

# **CMi5586DXLC133, CMi5486DXLC100HR, CMi5486DXLC66HR cpuModule™ User's Manual**

**BIOS Versions 4.7x**



***rtd***®  
USA  
[www.rtdusa.com](http://www.rtdusa.com)

**Real Time Devices USA, Inc.**  
*"Accessing the Analog World"®*



# **CMi5586DX133, CMi5486DX100HR and CMi5486DX66HR cpuModule™ User's Manual**



**REAL TIME DEVICES USA, INC.**  
200 Innovation Blvd  
PO Box 906  
State College, PA 16804-0906

Phone: +1-814-234-8087  
FAX: +1-814-234-5218

E-mail  
sales@rtdusa.com  
techsupport@rtdusa.com

website  
<http://www.rtdusa.com>

Revision History

2000.05.23 New 5xxx series

Publication CMi5586

Published by:

Real Time Devices USA, Inc.  
200 Innovation Blvd.  
P.O. Box 906  
State College, PA 16804-0906

Copyright 2000 by Real Time Devices USA, Inc.  
All rights reserved  
Printed in U.S.A.

PC/XT, PC/AT are registered trademarks of IBM Corporation.  
IBM is a registered trademark of International Business Machines Inc.  
MS-DOS is a registered trademark of Microsoft Corp.  
PC/104 is a registered trademark of PC/104 Consortium.

The Real Time Devices Logo is a registered trademark of Real Time Devices USA.  
cpuModule is a trademark of Real Time Devices USA.  
utilityModule is a trademark of Real Time Devices USA.

All other trademarks appearing in this document are the property of their respective owners.

<b>Chapter 1: Introduction</b> .....	<b>7</b>
The CMi5x86DXLC cpuModules .....	8
Specifications .....	10
<b>Chapter 2: Getting Started</b> .....	<b>13</b>
Basic Connector Locations .....	14
Default Configuration .....	15
Cable Kits .....	16
Connecting Power .....	17
Connecting the utility cable .....	18
Connecting a Keyboard .....	19
Connecting to the PC/104 Bus .....	20
Booting the cpuModule for the First Time .....	21
If You Misconfigure the cpuModule .....	22
For More Information .....	23
<b>Chapter 3: Connecting the cpuModule</b> .....	<b>25</b>
I/O Connections .....	26
Auxiliary Power, J9 .....	28
First Serial Port, J1 .....	29
Second Serial Port, J2 .....	31
Parallel Port, J3 .....	32
IDE Hard Disk, J4 and JP1 .....	34
Floppy Disk, J5 .....	36
Multifunction Connector, J6 .....	37
PC/104 Bus, J8 and J7 .....	39
<b>Chapter 4: Configuring the cpuModule</b> .....	<b>45</b>
Configuring Hardware .....	46
Configuring with the Setup program .....	50
<b>Chapter 5: Using the cpuModule</b> .....	<b>59</b>
The BIOS .....	64
BIOS Routines for Hardware Control .....	69
Direct Hardware Control .....	74
Storing Applications On-board .....	78
Using Virtual Devices .....	85
Utility Programs .....	90
<b>Chapter 6: Hardware Reference</b> .....	<b>95</b>
Jumpers .....	96
Solder Jumpers .....	99
Mechanical Dimensions .....	100
486DX100/66 Processor Thermal Management .....	101
5x86DX133 Processor Thermal Management .....	102
<b>Chapter 7: Troubleshooting</b> .....	<b>103</b>

Common Problems and Solutions .....	104
<b>Chapter 8: Limited Warranty .....</b>	<b>111</b>

# CHAPTER 1: INTRODUCTION

This manual is meant for users developing with the CMi5586DXLC133, CMi5486DXLC100HR or CMi5486DXLC66HR cpuModules. It contains information on hardware and software of the cpuModule.

The manual is organized as follows:

- Chapter 1: Introduction**  
Introduces main features and specifications.
- Chapter 2: Getting Started**  
Provides abbreviated instructions to get started.
- Chapter 3: Connecting the cpuModule**  
Provides information on connecting the cpuModule to peripherals.
- Chapter 4: Configuring the cpuModule**  
Provides information on configuring hardware and software.
- Chapter 5: Using the cpuModule**  
Provides information needed to develop applications for the cpuModule. The chapter includes general information on the cpuModule, plus detailed information on storing applications, using Virtual Devices and system functions, and using utility programs.
- Chapter 6: Hardware Reference**  
Lists jumpers and their locations and mechanical dimensions.
- Chapter 7: Troubleshooting**  
Offers advice on debugging problems with your system.
- Chapter 8: Warranty**

## The CMI5x86DXLC cpuModules

The PC/104 cpuModules described in this manual are designed for industrial applications which require:

- software and hardware compatibility with the PC/AT world
- high-speed "number-crunching" operation
- low power consumption
- small physical dimensions
- high reliability
- good noise immunity

This cpuModule is highly integrated, combining all major functions of a PC/AT computer on one compact board. It integrates all primary I/O functions of a AT compatible computer:

- floppy and hard disk interface
- keyboard interface
- Bidirectional parallel port
- two versatile RS232/422/485 serial ports
- Real Time Clock
- Speaker port

It also enhances standard AT-compatible computer systems by adding:

- two Solid State Disk socket
- a non-volatile configuration EEPROM
- a Watchdog Timer

The figure below shows a simplified block diagram of the cpuModule:

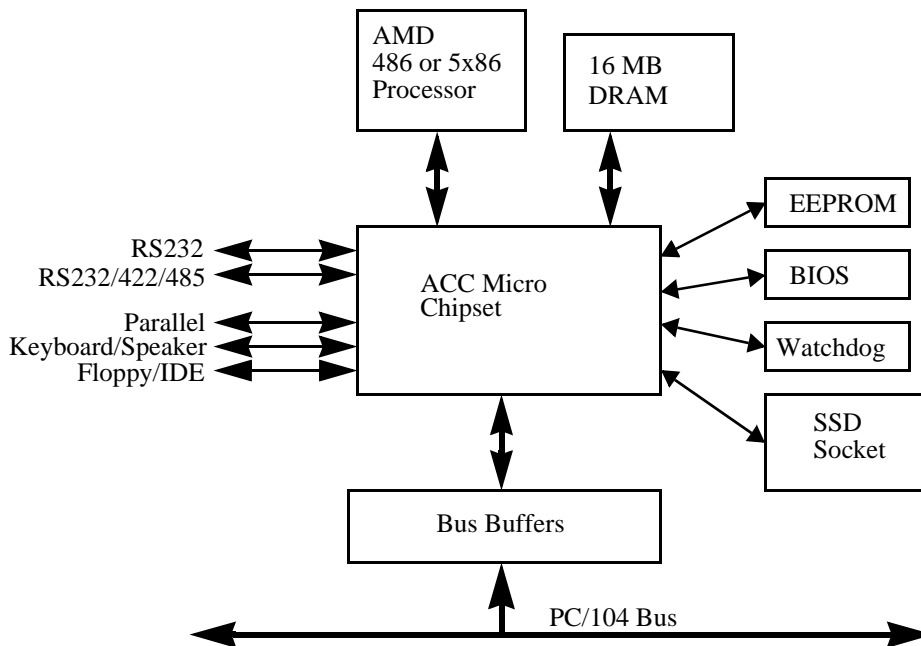

You can easily customize the cpuModule by stacking PC/104 modules such as video controllers, modems, LAN controllers, or analog and digital data acquisition modules. Stacking PC/104 modules on the cpuModule avoids expensive installations of backplanes and card cages and preserves the module's compactness.

A PC compatible BIOS is also implemented in the cpuModule. This BIOS supports ROM-DOS and MS-DOS operating systems. Drivers in the BIOS allow booting from floppy disk, hard disk, Solid State Disk, or DiskOnChip, thus enabling the system to be used with traditional disk drives or non-mechanical drives.

The cpuModule and BIOS are also compatible with most real-time operating systems for PC compatible computers, although these may require creation of custom drivers to use the SSD, EEPROM, and watchdog timer.

For industrial applications, a set of BIOS functions have also been implemented which allow easy control of system hardware devices.

# Specifications

## CMi5586DXLC133

- AMD Am5x86 microprocessor
- 133 MHz clock speed
- On-board 3.3 V processor supply
- 16 KB on-chip cache memory
- Math coprocessor

## CMi5486DXLC100HR

- AMD Am486 microprocessor
- 100 MHz clock speed
- Extended temperature processor
- On-board 3.3 V processor supply
- 16 KB on-chip cache memory
- Math coprocessor

## CMi5486DXLC66HR

- AMD Am486 microprocessor
- 66 MHz clock speed
- Extended temperature processor
- On-board 3.3 V processor supply
- 16 KB on-chip cache memory
- Math coprocessor

## DMA, Interrupts, Timers

- Six (6) DMA channels (8237 compatible)
- Fifteen (15) interrupt channels (8259 compatible)
- Three (3) counter/timers (8254 compatible)

## Memory Configurations

- 16 M bytes DRAM, installed

## Solid State Disk

- two 32-pin sockets
- an SSD socket can hold one of the following Conventional SSD devices:

Device	Full Read/Write Access	128Kbytes	256Kbytes	512Kbytes	1Mbyte
Atmel 5V Flash	yes	yes	yes	yes	N/A
SRAM	yes	yes	no	yes	N/A
NOVRAM	yes	yes	no	yes	N/A
12V Flash	no	yes	yes	N/A	N/A
EPROM	no	yes	yes	yes	yes
AMD 5V Flash	no	yes	no	yes	N/A

- an SSD socket can alternately hold one of the following devices which install using a

BIOS Extension:

Device	Full Read/Write Access	Maximum Number per cpuModule	Sizes
DiskOnChip 2000	yes	2	2 - 288 MB *
MCSI PromDisk	yes	2	4MB, 8MB *

(\*) Larger devices may be available in the future.

### Peripherals

- One serial port software configurable for RS232/422/485; baud rates from 50 to 115.2k baud (with 16550-type UARTs with 16-byte buffers)
- One RS-232 serial port; baud rates from 50 to 115.2k baud (with 16550-type UARTs with 16-byte buffers)
- Parallel port with SPP, bidirectional and ECP capability with selectable interrupts and DMA channel
- PC/AT standard keyboard port
- 360Kbyte to 1.44Mbyte floppy disk interface
- IDE hard disk interface
- Speaker port
- Real Time Clock (requires user-supplied external battery for backup)
- Watchdog Timer

### BIOS

- Directly supports Solid State Disk (SSD) and DiskOnChip
- User-configurable using built-in Setup program
- Supports serial link to host computer for keyboard, video, floppy, hard disk
- Can boot from floppy disk, hard disk, Solid State Disk, or serial port link (Virtual Devices)

### Connections

- AT bus, per PC/104 specifications (64-pin J8, 40-pin J7)
- Serial port 1 connector (10-pin J1)
- Serial port 2 connector (10-pin J2)
- Parallel port connector (26-pin J3)
- Multifunction connector (10-pin J6)
- Auxiliary power connector (8-pin J9)
- Floppy disk connector (34-pin J5)
- IDE connector (40-pin J4)

### Physical Characteristics

- Dimensions: 3.6 x 3.8 x 0.6" (97 x 100 x 16mm)
- Weight (mass): 3.4 ounces (100 grams)
- PCB: 12-layer, mixed surface-mount and thru-hole

### Operating environment

- Power supply: 5V +/- 5%
- 486DXLC100 processor operating temperature: -40 to +85 degrees C (with proper cooling) See *486DX100/66 Processor Thermal Management* on page 101
- 586DXLC133 processor operating temperature: -20 to +70 degrees C (with proper cooling) See *5x86DX133 Processor Thermal Management* on page 102
- Operating relative humidity: 0 to 95%, non-condensing
- Storage temperature : -55 to +125 degrees C.

## Power Consumption

Exact power consumption depends on the peripherals connected to the board, the selected SSD configuration and the memory configuration. These tests are for the cpuModule only without SSD.

The table below lists power consumption and relative performance in millions of instructions per second (MIPS) for boards at various clock speeds. The clock speed is programmable in the BIOS setup.

Typical Power Consumption					
cpuModule	Bus Speed MHz	Processor Speed MHz	Power at +5 VDC	MIPS	RAM MB
<b>CMi5586DXLC133</b>	33	133	6.7 W	32.2	16
	25	100	5.5 W	23.9	16
	20	80	4.7 W	19.0	16
	15	60	4.0 W	14.0	16
	10	40	3.2 W	9.0	16
<b>CMi5486DXLC100HR</b>	33	100	5.6 W	30.2	16
	25	75	4.7 W	22.4	16
	20	60	4.1 W	17.7	16
	15	45	3.5 W	12.9	16
	10	30	2.9 W	8.6	16
<b>CMi5486DXLC66HR</b>	33	66	4.6 W	28.0	16
	25	50	3.9 W	21.0	16
	20	40	3.5 W	16.7	16
	15	30	3.0 W	12.4	16
	10	20	2.6 W	8.2	16

For information on changing clock speeds, see *Processor Clock Control* on page 77.

## CHAPTER 2: GETTING STARTED

For many users, the factory configuration of the cpuModule can be used to get a PC/104 system operational. If you are one of these users, you can get your system up and running quickly by following a few simple steps described in this chapter. Briefly, these steps are:

- Connect power.
- Connect the utility cable.
- Connect a keyboard.
- Connect the PC/104 bus to a video card.

Refer to the remainder of this chapter for details on each of these steps.

## Basic Connector Locations

The figure and table below show the connectors used in this chapter.

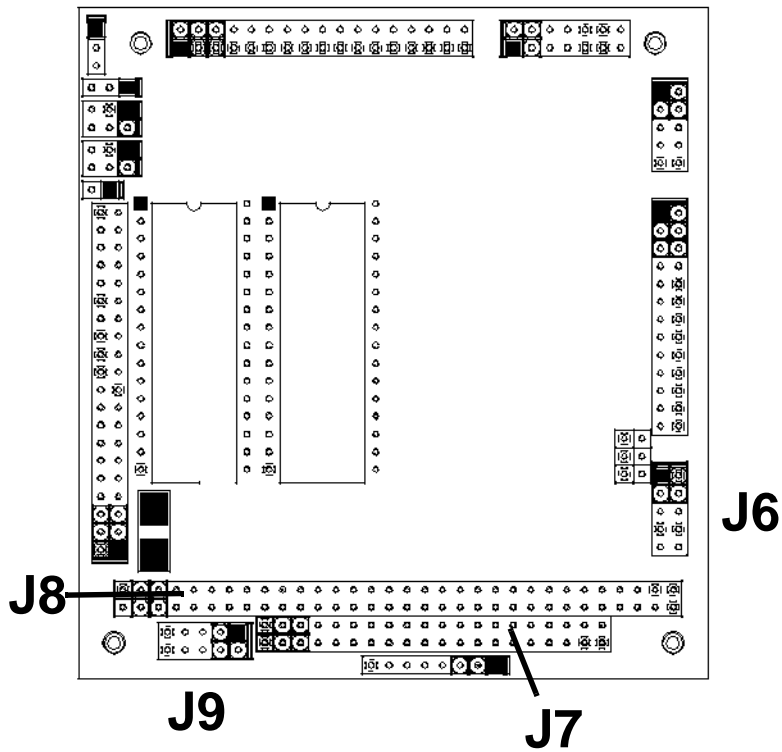

CMi Basic Connector Locations

Basic Connectors		
Connector	Function	Size
J8	PC/104 Bus (XT)	64 pin
J7	PC/104 bus (AT)	40 pin
J9	Auxiliary power	10 pin
J6	Multifunction	10 pin

For a complete listing of connectors, please refer to *I/O Connections* on page 26.

---

**NOTE!** Pin 1 of each connector is indicated by a square solder pad on the bottom of the PC board and a white box silkscreened on the top of the board.

---

## Default Configuration

Jumper JP6 is used to ensure that you can always get into setup, even if you disable the keyboard and display. The jumper should not be installed for normal operation. When JP6 is installed it forces the cpuModule to ignore all user setup information and boot with the default values outlined in the following table. With JP6 installed you can do two things:

- boot the cpuModules from a floppy disk
- press <Del> to run the Setup program and re-configure the cpuModule

This procedure is described in more detail at the end of this chapter.

Highlights of Default Setup		
Item	Setting	Controlled by:
Boot device	Floppy	Setup
SSD size/type	None	Setup + jumpers
Memory	16 MB	Setup
Video	EGA/VGA	Setup
Floppy Drive 1	1.44 M 3.5"	Setup
Floppy Drive 2	Not installed	Setup
Hard disk	Not installed	Setup

## ***Cable Kits***

For maximum flexibility, cables are not provided with the cpuModule. You may wish to purchase our cable kit for the cpuModule.

The XK-CM04 cable kit contains the following:

- Multifunction cable (keyboard socket, battery, reset, speaker)
- Floppy drive cable (DIL34 to two DIL34)
- IDE Hard drive cable (DIL40 to two DIL40)
- Two serial port cables (two - DIL10 to DSUB9)
- Parallel port cable (DIL26 to DSUB25)
- Power cable (DIL10 to wire leads)

## Connecting Power

---

**WARNING!** If you improperly connect power, the module will almost certainly be *damaged* or *destroyed*. Such damage is not warranted! Please verify connections to the module *before* applying power.

---

Power is normally supplied to the cpuModule through the PC/104 bus, connectors J8 and J7 . If you are placing the cpuModule onto a PC/104 stack that has a power supply, you do not need to make additional connections to supply power.

If you are using the cpuModule without a PC/104 stack or with a stack that does not include a power supply, refer to ***Auxiliary Power, J9*** on page 28 for more details.

## ***Connecting the utility cable***

The Multifunction connector, J6, implements the following interfaces:

- AT keyboard
- Speaker output
- System reset input
- Battery input

To use these interfaces, you must connect to the Multifunction connector, making sure the orientation of pin 1 is correct. If you are using the Multifunction cable from our cable kit, the cable provides a small speaker, a 5-pin circular DIN connector for the keyboard, a push-button for resetting the PC/104 system, and a lithium battery to provide backup power to the Real Time Clock.

To connect individual devices to the Multifunction connector, please see ***Multifunction Connector, J6*** on page 37.

## ***Connecting a Keyboard***

You may plug a PC/AT compatible keyboard directly into the circular DIN connector of the Multi-function cable in our cable kit. Some newer keyboards may use a smaller "mini-DIN" connector; you will need an adapter to plug these keyboards into the cpuModule.

---

**NOTE!** Many keyboards are switchable between PC/XT and AT operating modes, with the mode usually selected by a switch on the back or bottom of the keyboard. For correct operation with this cpuModule, you must select AT mode.

---

## Connecting to the PC/104 Bus

Since this cpuModule does not include a video display controller, you will probably wish to stack the cpuModule with another card to add video. For example, you may add the CM110 utilityModule, which adds a VGA display controller and flat-panel support on one PC/104 module.

The PC/104 bus connectors of the cpuModule are simply plugged onto a PC/104 stack to connect to other devices.

We recommend you follow the procedure below to ensure that stacking of the modules does not damage connectors or electronics.

---

**WARNING!** Do not force the module onto the stack! Wiggling the module or applying too much pressure may damage it. If the module does not readily press into place, remove it, check for bent pins or out-of-place keying pins, and try again.

---

- Turn off power to the PC/104 system or stack.
- Select and install standoffs to properly position the cpuModule on the PC/104 stack.
- Touch a grounded metal part of the rack to discharge any buildup of static electricity.
- Remove the cpuModule from its anti-static bag.
- Check that keying pins in the bus connector are properly positioned.
- Check the stacking order; make sure an XT bus card will not be placed between two AT bus cards or it will interrupt the AT bus signals.
- Hold the cpuModule by its edges and orient it so the bus connector pins line up with the matching connector on the stack.
- Gently and evenly press the cpuModule onto the PC/104 stack.

## ***Booting the cpuModule for the First Time***

You can now apply power to the cpuModule. Depending on the VGA card you are using, you may see a greeting message from the VGA BIOS. You will then see:

- the cpuModule BIOS version information
- You may see a message indicating jumper JP6 is installed and the default Setup is being used
- a message requesting you press {F1} to continue booting using the default Setup, or press {Delete} to enter the Setup program

If you press {F1}, the cpuModule will try to boot from the first floppy drive.

If you press {Delete}, the cpuModule will enter Setup. Once you have configured the cpuModule using Setup, save your changes, turn off power, remove jumper JP6, and reboot.

## ***If You Misconfigure the cpuModule***

It is possible you may incorrectly configure the cpuModule using Setup. If this happens, you have several choices:

If video and keyboard are enabled:

- Re-boot the cpuModule.
- Immediately press and hold down the {Delete} key until the cpuModule enters Setup.

If video or keyboard are disabled:

- Insert jumper JP6. This will force the cpuModule to boot using the default configuration, which enables video and keyboard.
- Boot the cpuModule.
- Press the {Delete} key to enter Setup.

If the option **<DEL> for Setup** is disabled in the Advanced Setup screen:

- Insert jumper JP6. This will force the cpuModule to boot using the default configuration, which enables the {Delete} key to run Setup.
- Boot the cpuModule.
- Press the {Delete} key to enter Setup.

You can then reconfigure the cpuModule correctly using Setup.

## ***For More Information***

This chapter has been intended to get the typical user up and running quickly. If you need more details, please refer to the following chapters for more information on configuring and using the cpu-Module.



# CHAPTER 3: CONNECTING THE CPU MODULE

This chapter contains information necessary to use all connectors of the `cpuModule`.

## ***I/O Connections***

## Connector Locations

The figure and table below show all connectors and the SSD socket of the cpuModule.

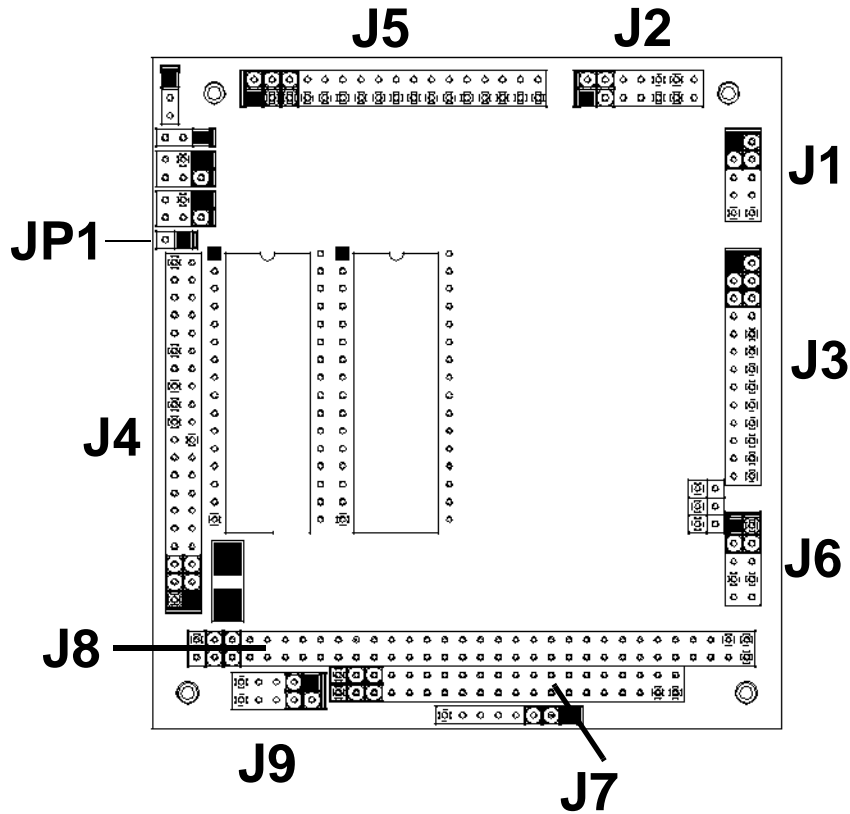

**CMi Connector Locations**

### Connectors

Connector	Function	Size
J1	Serial port #1	10 pin
J2	Serial port #2	10 pin
J3	Parallel port	26 pin
J4	IDE	40 pin
J5	Floppy	34 pin
J6	Multifunction	10 pin
J7	PC/104 bus (AT)	40 pin
J8	PC/104 bus (XT)	64 pin
J9	Auxiliary Power	10 pin
JP1	IDE Drive Activity	2 pin

---

**NOTE!** Pin 1 of each connector is indicated by a square solder pad on the bottom of the PC board and a white box silkscreened on the top of the board.

---

## Auxiliary Power, J9

---

**WARNING!** If you improperly connect power, the module will almost certainly be *destroyed*. Please verify power connections to the module *before* applying power.

---

The power supply can be conveyed to the module either through the PC/104 bus (J7 and J8) or through the Auxiliary Power connector, J9.

Facing the connector pins, the pinout of the Auxiliary Power connector is:

9	7	5	3	1
GND	-12V	+12V	-5V	+5V
GND	-12V	+12V	-5V	+5V
10	8	6	4	2

---

**NOTE!** -5VDC, +12VDC and -12VDC voltages are not used by the module, but are carried on the PC/104 bus connectors.

---

### Power Supply Protection

The cpuModule has protection circuitry which helps prevent damage due to problems with the +5V supply, such as:

- Reversed polarity
- Overvoltage
- Overcurrent

The circuitry includes a user-replaceable fuse, which is located near the PC/104 bus connector. This fuse is a:

- 2 amp Nano fuse
- Littelfuse part number R451 002

## First Serial Port, J1

The first serial port is implemented on connector J1. It is normally configured as a PC compatible full-duplex RS-232 port, but you may use the Setup program to re-configure it as RS-422 or RS-485. The I/O address and corresponding interrupt must also be selected using Setup. The available I/O addresses and the corresponding interrupts are shown in the following table

First Serial Port Settings		
I/O Address	Default IRQ	Optional IRQs
03F8H	IRQ4	IRQ3, IRQ5
02F8H	IRQ3	IRQ4, IRQ5

### First Serial Port UART

The first serial port is implemented with a 16550-compatible UART (Universal Asynchronous Receiver/Transmitter). This UART is capable of baud rates up to 115.2 kbaud, and includes 16-byte FIFOs on both receive and transmit. Please refer to any standard PC-AT hardware reference for the register map of the 16550-type UART.

### RS232 Serial Port (Default)

The full-duplex RS-232 mode is the default setting on the cpuModule. With this mode enabled, connector J3 must be connected to RS-232 compatible devices.

The following table gives the connector pinout and shows how to connect to an external serial connector, either XT(DB25) or AT(DB 9) compatible.

Connector J1: Pin Assignment in RS232 Mode					
Pin	Signal	Function	in/out	DB25	DB9
1	DCD	Data Carrier Detect	in	8	1
2	DSR	Data Set Ready	in	6	6
3	RXD	Receive Data	in	3	2
4	RTS	Request To Send	out	4	7
5	TXD	Transmit data	out	2	3
6	CTS	Clear To Send	in	5	8
7	DTR	Data Terminal Ready	out	20	4
8	RI	Ring Indicate	in	22	9
9,10	GND	Signal Ground	--	7	5

Facing the connector pins, the pinout is:

9	7	5	3	1
GND	DTR	TXD	RXD	DCD
GND	RI	CTS	RTS	DSR
10	8	6	4	2

### ***RS-422 or RS-485 Serial Port***

You may use Setup to configure the first serial port as RS-422 or RS-485. In this case, you must connect J3 to an RS-422 or RS-485 compatible device.

When using RS-422 or RS-485 mode, you can use the port in either half-duplex (two-wire) or full-duplex (four-wire) configurations. For half-duplex (2-wire) operation, you must connect RXD+ to TXD+, and connect RXD- to TXD-.

---

**NOTE!** A 120 ohm termination resistor is usually necessary on all RS-422 receivers and at the ends of the RS-485 lines.

---

### **RS-422 and RS-485 Mode Pinout**

The following table gives the pinout of connector J1 when RS-422 or RS-485 modes are enabled.

<b>Connector J1 in RS-422 or RS-485 Mode</b>				
<b>Pin</b>	<b>Signal</b>	<b>Function</b>	<b>in/out</b>	<b>DB9</b>
1	TXD+	Transmit Data (+)	out	1
2		Reserved		6
3	TXD-	Transmit Data (-)	out	2
4		Reserved		7
5	RXD+	Receive Data (+)	in	3
6		Reserved		8
7	RXD-	Receive Data (-)	in	4
8		Reserved		9
9,10	gnd	Signal ground	--	5

Facing the connector pins, the pinout is:

9	7	5	3	1
GND	RXD-	RXD+	TXD-	TXD+
GND	Rsvd	Rsvd	Rsvd	Rsvd
10	8	6	4	2

### ***Note when using RS-422 or RS-485 Mode***

When using the serial port in RS-422 or RS-485 mode, the serial transmitters are enabled and disabled under software control; the receivers are always enabled.

The transmitters are enabled by manipulating the Data Terminal Ready (DTR\*) signal of the first serial port controller. This signal is controlled by writing bit 0 of the Modem Control Register (MCR) as follows:

- If MCR bit 0 = 0, then DTR = 0, and serial transmitters are disabled
- If MCR bit 0 = 1, then DTR = 1, and serial transmitters are enabled

For more information on the serial port registers, including the MCR, please refer to a standard PC-AT hardware reference for the 16550-type UART.

## Second Serial Port, J2

The second serial port is implemented on connector J2. It is a PC compatible full-duplex RS-232 port. The I/O address and corresponding interrupt must also be selected using Setup. The available I/O addresses and the corresponding interrupts are shown in the following table

Second Serial Port Settings		
I/O Address	Default IRQ	Optional IRQs
02F8H	IRQ4	IRQ3, IRQ5
02E8H	IRQ3	IRQ4, IRQ5

### Second Serial Port UART

The second serial port is implemented with a 16550-compatible UART (Universal Asynchronous Receiver/Transmitter). This UART is capable of baud rates up to 115.2 kbaud, and includes 16-byte FIFOs on both receive and transmit. Please refer to any standard PC-AT hardware reference for the register map of the 16550-type UART.

### RS-232 Serial Port

The serial port is full-duplex RS-232. Connector J4 must be connected to RS-232 compatible devices.

The following table gives the connector pinout and shows how to connect to an external serial connector, either XT(DB25) or AT(DB 9) compatible.

Connector J2: Pin Assignment in RS232 Mode					
Pin	Signal	Function	in/out	DB25	DB9
1	DCD	Data Carrier Detect	in	8	1
2	DSR	Data Set Ready	in	6	6
3	RXD	Receive Data	in	3	2
4	RTS	Request To Send	out	4	7
5	TXD	Transmit data	out	2	3
6	CTS	Clear To Send	in	5	8
7	DTR	Data Terminal Ready	out	20	4
8	RI	Ring Indicate	in	22	9
9,10	GND	Signal Ground	--	7	5

Facing the connector pins, the pinout is:

9	7	5	3	1
GND	DTR	TXD	RXD	DCD
GND	RI	CTS	RTS	DSR
10	8	6	4	2

## Parallel Port, J3

The parallel port is available on connector J3. You can use Setup to select its address and associated interrupt.

The pinout of the connector allows a ribbon cable to directly connect it to a DB25 connector, thus providing a standard PC compatible port.

The following tables lists the parallel port signals and explains how to connect it to a DB25 connector to obtain a PC compatible port.

---

**NOTE!** For correct operation, keep the length of the cable connecting the cpu-Module and parallel device less than 3 meters (10 feet).

---

Parallel Port Connector, J3				
Pin	Signal	Function	in/out	DB25
1	STB	Strobe Data	out	1
2	AFD	Autofeed	out	14
3	PD0	Printer Data 0 (LSB)	out	2
4	ERR	Printer Error	in	15
5	PD1	Parallel Data 1	out	3
6	INIT	Initialize printer	out	16
7	PD2	Printer Data 2	out	4
8	SLIN	Select printer	out	17
9	PD3	Printer Data 3	out	5
10	GND	Signal ground	--	18
11	PD4	Printer Data 4	out	6
12	GND	Signal ground	--	19
13	PD5	Printer Data 5	out	7
14	GND	Signal ground	--	20
15	PD6	Printer Data 6	out	8
16	GND	Signal ground	--	21
17	PD7	Printer Data 7 (MSB)	out	9
18	GND	Signal ground	--	22
19	ACK	Acknowledge	in	10
20	GND	Signal ground	--	23

21	BSY	Busy	in	11
22	GND	Signal ground	--	24
23	PE	Paper End	in	12
24	GND	Signal ground	--	25
25	SLCT	Ready To Receive	in	13
26	GND	Signal ground	--	26

## IDE Hard Disk, J4 and JP1

A standard IDE (Integrated Drive Electronics) hard drive interface is available on connector J4. The pinout of this connector allows insertion of a ribbon cable to directly connect to one or two IDE hard drives.

To use the hard drive interface, you must configure the drive type using Setup. Refer to the section on Setup later in this chapter.

The cpuModule supports 'standard IDE' drives up to 528MB and, using a scheme called *Logical Block Addressing*, can also support drives larger than 528MB.

---

**NOTE!** You can connect an LED to jumper JP1 to indicate hard drive activity. The (+) terminal (anode) of the LED must be connected to pin 1 of JP1.

---

The following table lists the signals of the hard drive connector.

IDE Interface Connector			
Pin	Signal	Function	in/out
1	IDERESET	Reset HD	out
2	GND	Ground signal	--
3	HD7	HD data 7	in/out
4	HD8	HD data 8	in/out
5	HD6	HD data 6	in/out
6	HD9	HD data 9	in/out
7	HD5	HD data 5	in/out
8	HD10	HD data 10	in/out
9	HD4	HD data 4	in/out
10	HD11	HD data 11	in/out
11	HD3	HD data 3	in/out
12	HD12	HD data 12	in/out
13	HD2	HD data 2	in/out
14	HD13	HD data 13	in/out
15	HD1	HD data 1	in/out
16	HD14	HD data 14	in/out
17	HD0	HD data 0	in/out
18	HD15	HD data 15	in/out

19	GND	Ground signal	--
20	n.c.	not connected	--
21	n.c	not connected	--
22	GND	Ground signal	--
23	IOW	I/O Write	out
24	GND	Ground signal	--
25	IOR	I/O Read	out
26	GND	Ground signal	--
27	IOCHRDY	I/O Channel Ready	in
28	BALE	Bus Address Latch Enable	in
29	n.c.	not connected	
30	GND	Ground signal	--
31	IRQ14	Interrupt Request	in
32	IOCS16	16 bit transfer	in
33	A1	Address 1	out
34	n.c	not connected	--
35	A0	Address 0	out
36	A2	Address 2	out
37	HCS0	HD Select 0	out
38	HCS1	HD Select 1	out
39	LED	LED driving	in
40	GND	Ground signal	--

## Floppy Disk, J5

A standard floppy disk drive interface is available on connector J5. The pinout of this connector allows use of a ribbon cable to directly connect to one or two floppy drives. This interface supports floppy drives up to 1.44 MB capacity.

The floppy drive interface is configured by default to use one 3.5" 1.44 Meg drive. If you wish to use a different drive type or a second drive, you must configure the floppy drive interface using Setup. Refer to the section on Setup later in this chapter.

The following table lists and describes the signals of this connector.

Floppy Disk Drive Connector			
Pin	Signal	Function	In/out
2	RWC	write precompensation	out
4	n.c.	not connected	--
6	n.c.	not connected	--
8	INDEX	index pulse	in
10	MOTEN1	motor 1 enable	out
12	DRVSEL2	driver select 1	out
14	DRVSEL1	driver select 1	out
16	MOTEN2	motor 2 enable	out
18	DIRECTION	step direction	out
20	STEP	step pulse	out
22	WRDATA	write data	out
24	WREN	write enable	out
26	TRACK0	track 0 signal	in
28	WRPROT	write protect	in
30	RDDATA	read data	in
32	HEADSEL	head select	out
34	DSKCHG	disk change	in
ODD PINS	GND	ground signal	--

## Multifunction Connector, J6

The Multifunction connector on J6 implements the following functions:

- Speaker output
- AT keyboard
- System reset input
- Watchdog Timer output
- Battery Input

The following table gives the pinout of the Multifunction connector.

Multifunction Connector, J6			
Pin	Signal	Function	in/out
1	SPKR+	Speaker output	out
2	SPKR-	Speaker output	out
3	RESET	External reset	in
4	WD	Watchdog output	out
5	KBD	Keyboard Data	in
6	KBC	Keyboard Clock	out
7	GND	Ground	--
8	KBP	Keyboard Power	out
9	BAT	Battery input	in
10	N/C		--

Facing the connector pins, the pinout is:

9	7	5	3	1
BAT	GND	KBD	RESET	SPKR+
N/C	KBP	KBC	WD	SPKR-
10	8	6	4	2

### Speaker

A speaker output is available on two pins of the Multifunction connector. These outputs are controlled by a transistor to supply 0.1 watt of power to an external speaker. The external speaker should have 8 ohm impedance.

### Keyboard

An AT compatible keyboard can be connected to the Multifunction connector. Usually PC keyboards come with a cable ending with a 5-pin male 'DIN' connector. The following table lists the relationship between the Multifunction connector pins and a standard 'DIN' keyboard connector.

To ensure correct operation, check that the keyboard is either an AT compatible keyboard or a switchable XT/AT keyboard set to AT mode. Switchable keyboards are usually set by a switch on the back or bottom of the keyboard.

Keyboard Connector			
Pin	Signal	Function	DIN
5	KBD	Keyboard Data	2
6	KBC	Keyboard Clock	1
7	GND	Ground	4
8	KBP	Keyboard Power	5

### ***System Reset***

Pin 3 of the multifunction connector allows connection of an external push-button to manually reset the system. The push-button should be normally open, and connect to ground when pushed.

### ***Watchdog Timer***

The active-high Watchdog signal generated on the cpuModule is available on pin 4 of the multifunction connector. The Watchdog time-out period is 1.2 seconds. If the Watchdog timer is not reset within that period, the Watchdog signal is asserted and the cpuModule is reset.

See ***Watchdog Timer Control*** on page 73 for more information on controlling the Watchdog Timer.

### ***Battery***

Pin 9 of the multifunction connector is the connection for an external backup battery (in the range 2.40V to 4.15V; typically 3.0 or 3.6V). This battery is used by the cpuModule when system power is removed, to:

- preserve the date and time in the Real Time Clock
- preserve information stored in Static RAM in the Solid State Disk

If you wish to back-up Static RAMs in the Solid State Disk, please note that:

- jumpers must be correctly set;  
see ***Storing Applications On-board*** on page 78
- SSD backup requires considerable battery power;  
you may require a larger backup battery than supplied with the cable kit

## PC/104 Bus, J8 and J7

Connectors J8 and J7 carry signals of the PC/104 bus; these signals match definitions of the IEEE P996 standard. The following tables list the pinouts of the PC/104 bus connectors.

The following table lists the signals of the XT portion of the PC/104 bus.

PC/104 XT Bus Connector, J8		
Pin	Row A	Row B
1	N.C.	0V
2	SD7	RESETDRV
3	SD6	+5V
4	SD5	IRQ2
5	SD4	-5V
6	SD3	DRQ2
7	SD2	-12V
8	SD1	N.C.
9	SD0	+12V
10	IOCHRDY	(Keying pin)
11	AEN	SMEMW*
12	SA19	SMEMR*
13	SA18	IOW*
14	SA17	IOR*
15	SA16	DACK3*
16	SA15	DRQ3
17	SA14	DACK1*
18	SA13	DRQ1
19	SA12	REFRESH*
20	SA11	SYSCLK
21	SA10	IRQ7
22	SA9	IRQ6
23	SA8	IRQ5
24	SA7	IRQ4
25	SA6	IRQ3
26	SA5	DACK2*
27	SA4	TC
28	SA3	BALE
29	SA2	+5V
30	SA1	OSC
31	SA0	0V
32	0V	0V

The following table lists signals of the AT portion of the PC/104 bus.

PC/104 AT Bus Connector, J7		
Pin	Row C	Row D
1	0V	0V
2	SBHE*	MEMCS16*
3	LA23	IOCS16*
4	LA22	IRQ10
5	LA21	IRQ11
6	LA20	IRQ12 Used internally
7	LA19	IRQ15
8	LA18	IRQ14
9	LA17	DACK0*
10	MEMR*	DRQ0
11	MEMW*	DACK5*
12	SD8	DRQ5
13	SD9	DACK6*
14	SD10	DRQ6
15	SD11	DACK7*
16	SD12	DRQ7
17	SD13	+5V*
18	SD14	MASTER*
19	SD15	0V
20	(Keying pin)	0V

**Notes:**

Keying pin positions are blanked to prevent misalignment of stacked modules. This is a feature of the PC/104 specification and should be implemented on all mating PC/104 modules.

Signals marked with (\*) are active-low.

All bus lines can drive a maximum current of 6mA at TTL voltage levels.

## PC/104 Bus Signals

The following table contains brief descriptions of the PC/104 bus signals.

Signal	I/O	Description
AEN	O	Address ENable: when this line is active (high), it means a DMA transfer is being performed and therefore the DMA controller has control over the data bus, the address bus, and the control lines.
BALE	O	Bus Address Latch Enable, active high. When active, it indicates that address lines SA0 to SA19 are valid.
DACKx*	O	DMA ACKnowledge x=0-7, active low, used to acknowledge DMA requests.
DRQx	I	DMA Request x=0-7: these are asynchronous lines used by peripheral devices to request DMA service. They have increasing priority from DRQ0 up to DRQ7. A DMA request is performed by setting the DRQ line high and keeping it high until the corresponding DACK line is activated.
ENDXFR*	I/O	This is the only synchronous signal of the PC/104 bus and it is active low. It indicates that the current bus cycle must be performed with 0 wait states. It is used only for 16-bit boards.
IOCHCHK*	I	I/O Channel Check, active low, indicates an error condition that cannot be corrected.
IOCHRDY	I	I/O Channel Ready: this line, usually high (ready) is pulled to a low level by devices which need longer bus cycles.
IOCS16*	I	I/O Chip Select 16-bit: this line, active low, is controlled by devices mapped in the I/O address space. It indicates they have a 16-bit bus width.
IOR*	O	I/O Read, active low, indicates when the devices present on the bus can send their information on the data bus.
IOW*	O	I/O Write, active low. When active, it allows the peripheral devices to read data present on the data bus.
IRQx	I	Interrupt Request: x = 2 to 15, active on rising edge. IRQ15 has top priority; the other lines have decreasing priority starting from IRQ14 down to IRQ2. An interrupt request is performed by changing the level of the corresponding line from low to high and keeping it high until the microprocessor has recognized it.
KEY	N/A	These locations contain mechanical keying pins to help prevent incorrect connector insertion.
LA23..LA17	O	These signals select a 128kbyte window in the 16Mbyte address space available on the bus.

MASTER*	I	During a DMA cycle, this active-low signal, indicates that a resource on the bus is about to drive the data and address lines.
MEMCS16*	I	Memory Chip Select 16-bit: this line, active low, is controlled by devices mapped in the memory address space and indicates they have a 16-bit bus width.
MEMR*	I/O	This active-low signal indicates a memory read operation. Devices using this signal must decode the address on lines LA23..LA17 and SA19..SA0.
MEMW*	I/O	This active-low signal indicates a memory write operation. Devices using this signal must decode the address on lines LA23..LA17 and SA19..SA0.
OSC	O	OSCillator: clock with a 70 ns period and a 50% duty cycle. It is a 14.31818MHz always presents.
REFRESH*	O	This line is active low and indicates that the current bus cycle is a DRAM refresh cycle. The refresh cycles are activated every 15 microseconds.
RESETDRV	O	This line, active high, is used to reset the devices on the bus, at power-on or after a reset command.
SA0..19	O	Address bits 0 to 19: these lines are used to address the memory space and the I/O space. SA0 is the least significant bit while SA19 is the most significant bit.
SBHE*	O	This active-low signal indicates a transfer of the most significant data byte (SD15..SD8).
SD8..15	I/O	Data bits: these are the high-byte data bus lines. SD8 is the least significant bit; SD15 the most significant bit.
SD0..7	I/O	Data bits: these are the low-byte data bus lines. SD0 is the least significant bit; SD7 the most significant bit.
SMEMR*	O	Memory Read command, active low.
SMEMW*	O	Memory Write command, active low.
SYSCLK	O	System Clock, 8.0MHz with a 50% duty cycle. Only driven during external bus cycles.
TC	O	Terminal Count: this line is active high and indicates the conclusion of a DMA transfer.

## **PC/104 Bus Termination**

Termination of PC/104 bus signals is not recommended and may cause malfunctions of the cpuModule. If termination must be applied, it should be a series termination of a resistor and capacitor, not exceeding 40-60 ohms and 30-70 pF, between each signal and ground.



# CHAPTER 4: CONFIGURING THE CPU MODULE

This chapter contains information to configure the cpuModule.

Topics covered in this chapter include:

- Configuration jumpers
- Adding SSD Memory
- Configuring Using the Setup Program

***Configuring Hardware***

## Jumpers

Many cpuModule options are configured by positioning jumpers. Jumpers are labeled on the board as “**JP**” followed by a number.

Some jumpers are three pins, allowing three settings:

- pins 1 and 2 connected (indicated as "1-2")
- pins 2 and 3 connected (indicated as "2-3")
- no pins connected.

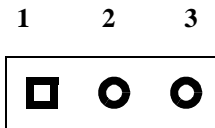

Some jumpers are two-pin, allowing two settings:

- pins 1 and 2 connected (indicated as "closed")
- pins 1 and 2 un-connected (indicated as "open")

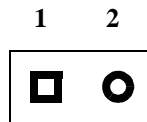

## Installing SSD Memory

This section explains how to add devices to the cpuModule. This procedure is only necessary when you wish to add or change:

- Solid State Disk memory devices

### Installing SSD Memory in U9

You may wish to install SSD memory to use the cpuModule as a "diskless" stand-alone device.

Refer to *Ways to Use the Solid State Disk Sockets* on page 79 for more information on various SSD device types. Solid State Disk memories are placed in socket U1.

The following table lists possible configurations for the SSD socket:

SSD Devices in U9						
Type	Part	Operation	Capacity	JP2	JP3	Notes
Atmel 5V Flash	29C010A	read/write	128KB	3-4	1-2	
	29C040A	read/write	512KB	1-2	1-2	
BIOS Extension Devices	DiskOnChip and PromDisk	read/write	to 288MB+	1-2	1-2	
SRAM	128KB	read/write	128KB	3-4	1-2	no backup
				3-4	2-3	battery backup
	512KB	read/write	512KB	1-2	1-2	no backup
				1-2	2-3	battery backup
NOVRAM	DS1645Y	read/write	128KB	3-4	1-2	
	DS1650Y	read/write	512KB	1-2	1-2	
12V Flash	28F010	read-only	128KB	3-4	1-2	read-only
				5-6	1-2	Programming with SSD.EXE
	28F020	read-only	256KB	3-4	1-2	read-only
				5-6	1-2	Programming with SSD.EXE
AMD 5V Flash	29F010	read-only	128KB	3-4	1-2	program or read
	29F040	read-only	512KB	1-2	1-2	program or read
EPROM	27C010	read-only	128KB	3-4	1-2	read only
	27C020	read-only	256KB	3-4	1-2	read only
	27C040	read-only	512KB	1-2	1-2	read only
	27C080	read-only	1MB	1-2	1-2	read only

### Installing SSD Memory in U10

You may wish to install SSD memory to use the cpuModule as a "diskless" stand-alone device.

Refer to *Ways to Use the Solid State Disk Sockets* on page 79 for more information on various SSD device types. Solid State Disk memories are placed in socket U1.

The following table lists possible configurations for the SSD socket:

SSD Devices in U10						
Type	Part	Operation	Capacity	JP4	JP5	Notes
Atmel 5V Flash	29C010A	read/write	128KB	3-4	1-2	
	29C040A	read/write	512KB	1-2	1-2	
BIOS Extension Devices	DiskOnChip and PromDisk	read/write	to 288MB+	1-2	1-2	
SRAM	128KB	read/write	128KB	3-4	1-2	no backup
				3-4	2-3	battery backup
	512KB	read/write	512KB	1-2	1-2	no backup
				1-2	2-3	battery backup
NOVRAM	DS1645Y	read/write	128KB	3-4	1-2	
	DS1650Y	read/write	512KB	1-2	1-2	
12V Flash	28F010	read-only	128KB	3-4	1-2	read-only
				5-6	1-2	Programming with SSD.EXE
	28F020	read-only	256KB	3-4	1-2	read-only
				5-6	1-2	Programming with SSD.EXE
AMD 5V Flash	29F010	read-only	128KB	3-4	1-2	program or read
	29F040	read-only	512KB	1-2	1-2	program or read
EPROM	27C010	read-only	128KB	3-4	1-2	read only
	27C020	read-only	256KB	3-4	1-2	read only
	27C040	read-only	512KB	1-2	1-2	read only
	27C080	read-only	1MB	1-2	1-2	read only

## ***Configuring with the Setup program***

The cpuModule Setup program allows you to customize the cpuModule's configuration. Selections made in Setup are stored on the board and read by the BIOS at power-on.

Setup for this cpuModule is called CMiSET. It is in three places:

- In the board's BIOS ROM, activated by the {Delete} key during boot
- In the Utility SSD provided in the first SSD socket
- On the utility disk supplied with the cpuModule.

The following section explains how to start Setup.

### ***Starting Setup***

You can run Setup one of several ways:

- Re-boot the cpuModule, and hold down the {Delete} key.
- Install default jumper JP6, boot the cpuModule, and press the {Delete} key.
- Boot the cpuModule, change to the Utility SSD, and run CMiSET.EXE.
- Boot the cpuModule, change to a diskette containing CMiSET.EXE, and run CMiSET.

When you are finished with Setup, save your changes and exit. If you are using Setup from the BIOS, the system will automatically reboot. Otherwise, you must manually do a hard reset, by pushing the reset push-button or cycling power.

If jumper JP6 was installed, make sure you turn off the cpuModule, remove the jumper, and reboot so the changes are recognized.

### ***Using the Setup Program***

All displays in Setup consist of two areas. The upper area lists the available selections. The lower area displays help messages which you should always read.

### ***Main Menu Options***

From the Main menu, you may choose:

- *Standard Setup* to access commonly used settings for the keyboard, floppy drives, hard disks, and SSD.
- *Advanced Setup* to access less-used settings for memory, the SSD, and error-handling.
- *Save Changes and Exit* to save your changes and exit Setup.
- *Exit Without Saving Changes* to leave Setup without saving your changes.

Normally you will use the first two selections to make changes to the cpuModule configuration, then use the *Save Changes and Exit* selection.

The version of Setup in the BIOS ROM will automatically cause a hard reset after you exit.

The DOS version of Setup (in the utility SSD and on floppy disk) has two added options:

- *Read settings from a File* which reads settings from a file on a disk
- *Save Settings to a File* which saves settings to a file on disk

These allow users to configure large numbers of modules without manually entering the settings each time.

The following sections describe each of these choices in detail.

## Field Selection

You move between fields in Setup using the keys listed below.

Setup Keys	
Key	Function
↓	selects next field
↑	selects previous field
{TAB}	selects next field on the right or first field of next line
→	selects next value in field
←	selects former value in field
{ESC}	returns to main menu

## Standard Setup Fields

The following is an alphabetical list of Standard Setup fields.

Standard Setup Fields		
Field	Active keys	Selections
Boot Device	← →	Selects the primary boot device. Possible selections: <ul style="list-style-type: none"><li>• Floppy Disk</li><li>• SSD (Solid State Disk)</li><li>• Hard Disk</li></ul> <ul style="list-style-type: none"><li>• This selects the device from which system boot is first attempted.</li><li>• Hard Disk is used to boot from Hard Disk or a BIOS Extension device in an SSD socket.</li></ul>
Date	{0..9},{↵}	Sets the date with the format: <ul style="list-style-type: none"><li>• month / day / year</li><li>• You must connect a backup battery, or this setting will be lost at power down.</li></ul>
Hard disk 1 type Hard disk 1 table	{0..9} {↵}	Selects the first hard disk type. Selections are: <ul style="list-style-type: none"><li>• Not Installed</li><li>• Standard : (drives under 1024 Cylinders)</li><li>• Serial: for Virtual Devices mode.</li></ul> <ul style="list-style-type: none"><li>• When using Standard, manually enter parameters under Hard Disk 1 Table. LBA parameters will be calculated automatically.</li></ul>

Hard disk 2 type Hard disk 2 table	← → {0..9} {↵}	Selects the second hard disk type. Selections are: <ul style="list-style-type: none"> <li>• Not Installed</li> <li>• Standard: (drives under 1024 Cylinders)</li> <li>• When using Standard, manually enter parameters under Hard Disk 2 Table. LBA parameters will be calculated automatically.</li> </ul>
Floppy Disk 1	← →	Selects the format of floppy disk 1: Selections are: <ul style="list-style-type: none"> <li>• 360KB</li> <li>• 720KB</li> <li>• 1.2MB</li> <li>• 1.44MB</li> <li>• Serial (Used in Virtual Devices mode)</li> </ul>
Floppy Disk 2	← →	Selects the format of floppy disk 2: Selections are: <ul style="list-style-type: none"> <li>• 360KB</li> <li>• 720KB</li> <li>• 1.2MB</li> <li>• 1.44M</li> </ul>
Serial Port J1	← →	Selects the address and type of the first serial port. Selections are: <ul style="list-style-type: none"> <li>• RS-232 at 03F8H (default)</li> <li>• RS-232 at 02F8H</li> <li>• RS-232 at 03E8H</li> <li>• RS-232 at 02E8H</li> <li>• RS-422/485 at 03F8H</li> <li>• RS-422/485 at 02F8H</li> <li>• RS-422/485 at 03E8H</li> <li>• RS-422/485 at 02E8H</li> <li>• RS-232 Virtual Devices</li> <li>• RS-422/485 Virtual Devices</li> <li>• Disabled</li> </ul>
Serial Port J2	← →	Selects the address and type of the second serial port. Selections are: <ul style="list-style-type: none"> <li>• RS-232 at 03F8H</li> <li>• RS-232 at 02F8H (default)</li> <li>• RS-232 at 03E8H</li> <li>• RS-232 at 02E8H</li> <li>• RS-232 Virtual Devices</li> <li>• Disabled</li> </ul>
Keyboard	← →	Selects the keyboard mode. Selections are: <ul style="list-style-type: none"> <li>• Disabled</li> <li>• ATkey: AT keyboard present</li> <li>• Serial (Used in Virtual Devices mode)</li> </ul>

Memory Size	← →	Selects the size of installed dynamic RAM (DRAM). Selections are • 16M Byte Selecting an incorrect value may cause malfunctions.
Parallel Port	← →	Selects parallel port address Selections are: • 378h (default) • 278h • Disabled
Time	{0..9},{-}	Sets the time with the format: • hours : minutes : seconds  You must connect a backup battery or this setting will be lost at power down.
Video State	← →	Selects video mode. Selections are: • Monochrome • CGA, 40 by 25 • CGA, 80 by 25 • EGA/VGA • Serial (Used in Virtual Devices mode) • Not Installed  Selecting 'Not Installed' will not prevent accesses to the video controller, which may cause unpredictable results.

### *Advanced Setup Fields*

The following is a list of Advanced Setup fields.

<b>Advanced Setup Fields</b>		
<b>Field</b>	<b>Active keys</b>	<b>Selections</b>
SSD Socket U9	← →	Selects the device type installed in SSD socket U9.  • The setting here must match the actual device installed in the socket. • Jumpers JP2 and JP3 must be set correctly.
SSD Socket U10	← →	Selects the device type installed in SSD socket U10.  • The setting here must match the actual device installed in the socket. • Jumpers JP4 and JP5 must be set correctly.

SSD Window	← →	<p>Selects the 16Kbyte address range where the SSD is mapped.</p> <p>Selections are:</p> <ul style="list-style-type: none"> <li>• D0000H (to D7FFFH)</li> <li>• D8000H (to DFFFFH)</li> <li>• E0000H (to E7FFFH)</li> <li>• E8000H (to EFFFFH)</li> </ul> <p>When selecting the address range, you <i>must ensure</i> that:</p> <ul style="list-style-type: none"> <li>• no other devices are mapped to the same memory addresses</li> <li>• shadow memory is not enabled at the same memory addresses</li> <li>• selection does not conflict with selection of BIOS EXT@D000 / D800 / E000 / E800</li> <li>• BIOS EXT devices use an 32 Kbyte address block</li> </ul>
IRQ3 Source	← →	<p>Determines source for IRQ3 interrupt.</p> <ul style="list-style-type: none"> <li>• Disabled</li> <li>• Serial J1</li> <li>• Serial J2(default)</li> </ul> <p>If set to disabled, IRQ3 may be an input from the PC/104 bus.</p>
IRQ4 Source	← →	<p>Determines source for IRQ4 interrupt.</p> <ul style="list-style-type: none"> <li>• Disabled</li> <li>• Serial J1 (default)</li> <li>• Serial J2</li> </ul> <p>If set to disabled, IRQ4 may be an input from the PC/104 bus.</p>
IRQ5 Source	← →	<p>Determines source for IRQ5 interrupt.</p> <ul style="list-style-type: none"> <li>• Disabled (default)</li> <li>• Serial J1</li> <li>• LPT</li> </ul> <p>If set to disabled, IRQ5 may be an input from the PC/104 bus.</p>
IRQ7 Source	← →	<p>Determines source for IRQ7 interrupt.</p> <ul style="list-style-type: none"> <li>• Disabled</li> <li>• LPT (default)</li> <li>• Serial J2</li> </ul> <p>If set to disabled, IRQ7 may be an input from the PC/104 bus.</p>

Shadow C000h-C7FFh  Shadow C800-CFFFh  Shadow D000-DFFFh	← →	<p>Enables shadowing of the BIOS and memory. Selections are:</p> <ul style="list-style-type: none"> <li>• Enabled: address range is copied (shadowed) to RAM.</li> <li>• Disabled: address range remains mapped on the bus.</li> </ul> <p>In DOS systems, addresses between A0000H and FFFFFH are usually reserved for devices mapped on the bus. Accesses to these addresses are slower than accesses to system memory (RAM). The shadow options copy code from these addresses into RAM, improving general performance of the system.</p>
Segment E000h Map	← →	<p>Selects mapping of segment E000h of memory. Selections are:</p> <ul style="list-style-type: none"> <li>• PC/104 Bus</li> <li>• BIOS ROM</li> </ul> <p>When PC/104 Bus is selected, addresses in segment E0000-EFFFFh are free for external use.</p> <p>When BIOS ROM is selected, this segment is mapped into the on-board BIOS ROM chip. This selection will cause Setup to be executed at every boot, whether or not {Delete} is pressed.</p>
Boot Type	← →	<p>Selects boot type. Selections are:</p> <ul style="list-style-type: none"> <li>• Standard: Will perform RAM scan/checking</li> <li>• Quick: Will skip RAM scan/checking</li> </ul>
Chipset Error	← →	<p>Defines reaction to errors in microprocessor, coprocessor, timer, or DMA and interrupt controller initialization.</p> <p>ON: prints error warning OFF: continue without warning</p>
Memory error	← →	<p>Defines reaction to errors during memory tests.</p> <p>ON: prints error warning OFF: continue without warning</p> <p>This setting only applies during the following power-on tests:</p> <ul style="list-style-type: none"> <li>• memory size (base and extended)</li> <li>• memory test (base and extended)</li> </ul>
Video Error	← →	<p>Defines reaction to video initialization errors:</p> <p>ON: prints error warning OFF: continue without warning</p>
Keyboard Error	← →	<p>Defines reaction to keyboard initialization errors.</p> <p>ON: prints error warning OFF: continue without warning</p>

Floppy Error	← →	Defines reaction to floppy drive errors. ON: prints error warning OFF: continue without warning
Hard Disk Error	← →	Defines reaction to hard disk errors. ON: prints error warning OFF: continue without warning
RTC Error	← →	Defines reaction to Real Time Clock initialization errors. ON: prints error warning OFF: continue without warning  <ul style="list-style-type: none"> <li>When off is selected, the time and date default to 00:00:00 and 01/01/1990 in case of an error</li> </ul>
Clock/Bus Speed	← →	<ul style="list-style-type: none"> <li>33.3 (default for 66, 100 or 133 MHz operation)</li> <li>25</li> <li>20</li> <li>15</li> <li>10</li> </ul>
<DEL> for Set-up	← →	Determines whether pressing the {Delete} key during boot will run the Setup program. <ul style="list-style-type: none"> <li>Enable</li> <li>Disable</li> </ul> <ul style="list-style-type: none"> <li>In some cases it may be desirable to disable this feature.</li> <li>To re-enable the {Delete} key, insert JP6 and re-boot the cpuModule, then change this setting.</li> </ul>

### ***Save Changes and Exit***

If you select this menu item, your changes are stored on the cpuModule. If you were running Setup from the BIOS ROM, the cpuModule automatically reboots. Changes will become effective the next time the cpuModule boots, as long as jumper JP6 is removed.

### ***Exit Without Saving Changes***

If you select this menu item, your changes are not stored on the cpuModule. If you were running Setup from the BIOS ROM, the cpuModule automatically reboots. Nothing in the cpuModule configuration will be changed, even after the reboot.

### ***Read Settings from a File***

If you select this menu item, you are prompted for a file which contains settings to be loaded. The settings will not be saved to the board unless you select Save Changes and Exit.

### ***Save Settings to a File***

If you select this menu item, you are prompted for the name of a file to which settings will be saved (a file name with extension). These settings may be moved to another cpuModule, or used to configure a number of cpuModules identically.



# CHAPTER 5: USING THE CPU MODULE

This chapter provides information for users who wish to develop their own applications programs for the cpuModule.

This chapter includes information on the following topics:

- Memory map
- I/O Address map
- Interrupts
- Power On Self Tests (POSTs)
- System Functions (EEPROM, Watchdog Timer, Real Time Clock)
- Virtual Devices
- Storing Applications in Solid State Disk
- Utility Programs (SSD and BIOSBLD)

## Memory Map

The module addresses memory using 24 address lines. This allows a maximum of  $2^{24}$  locations, or 16 Megabytes of memory.

The table below shows how memory in the first megabyte is allocated in the system.

First Megabyte Memory Map	
<b>FFFFFH- F0000H</b>	BIOS in Flash EPROM
<b>EFFFFH- E0000H</b>	User memory space which is normally free. The Advanced Setup screen allows this segment to be mapped into the BIOS ROM or onto the PC/104 bus. The BIOS ROM contains Set-up in this location.
<b>DFFFFH- C0000H</b>	User memory space. Usually, memory between C0000H and C7FFFH is used for the BIOS of add-on VGA video cards.
<b>BFFFFH- A0000H</b>	Normally used for video RAM as follows:  CGA                    0B8000H to 0BFFFFH EGA/VGA            0A0000H to 0AFFFFH Monochrome        0B0000H to 0B7FFFH
<b>9FFFFH- 00502H</b>	DOS reserved memory area
<b>00501H- 00400H</b>	BIOS data area
<b>003FFH- 00000H</b>	Interrupt vector area

Memory beyond the first megabyte can be accessed in protected mode, by using EMS or a similar memory manager. See your OS or programming language references for information on memory managers.

## Input/Output Address Map

As with all standard PC/104 boards, the Input/Output (I/O) space is addressed by 10 address lines (SA0-SA9). This allows  $2^{10}$  or 1024 distinct I/O addresses. Any add-on modules you install must therefore use I/O addresses in the range 0-1024 (decimal) or 000-FFF (hex).



If you add any PC/104 modules or other peripherals to the system you must ensure they *do not* use reserved addresses listed below, or mal-functions will occur.

The table below lists I/O addresses reserved for the cpuModule.

I/O Addresses Reserved for the cpuModule		
Address Range	Bytes	Device
000H-00FH	16	DMA Controller
010H-01FH	16	Reserved for CPU
020H-021H	2	Interrupt Controller #1
022H-02FH	13	Reserved
040H-043H	4	Timer
060H-064H	5	Keyboard Interface
070H-071H	2	Real Time Clock port
080H-08FH	16	DMA page register
0A0H-0A1H	2	Interrupt controller #2
0C0H-0DFH	32	DMA controller #2
0F0H-0FFH	16	Math co-processor
1F0H-1FFH	16	Hard disk <sup>1</sup>
2F8H-2FFH	8	Serial port <sup>2</sup>
378H-37FH	8	Parallel port <sup>3</sup>
3BCH-3BFH	4	Parallel port <sup>3</sup>
3E8H-3EFH	8	Serial port <sup>2</sup>
3F0H-3F7H	8	Floppy disk <sup>1</sup>
3F8H-3FFH	8	Serial port <sup>2</sup>

<sup>1</sup> If the floppy and/or hard drive controllers are disabled, the I/O addresses listed will not be occupied.

<sup>2</sup> Only one of the I/O addresses shown for a Serial port is active at any time. You can use Setup to select which one is active or to disable it entirely.

<sup>3</sup> Only one of the I/O addresses shown for the Parallel printer port is active at any time. You can use Setup to select which one is active or to disable it entirely.

## Hardware Interrupts



If you add any PC/104 modules or other peripherals to the system you must ensure they *do not* use interrupts needed by the cpuModule, or malfunctions will occur

The cpuModule supports the standard PC interrupts listed below. Interrupts not in use by hardware on the cpuModule itself are listed as 'available'.

Hardware Interrupts Used on the cpuModule		
Interrupt	Normal Use	Source
0	Timer 0	ACC chipset
1	Keyboard	ACC chipset
2	Cascade of IRQ 8-15	ACC chipset
3	COM2	ACC chipset
4	COM1	ACC chipset
5	available	XT bus
6	Floppy <sup>1</sup>	XT bus
7	Printer	ACC chipset
8	Real Time Clock	ACC chipset
9	available	Mapped to IRQ 2 on XT bus
10	available	AT bus
11	available	AT bus
12	Not available	ACC chipset
14	IDE hard disk <sup>2</sup>	AT bus
15	available	ACC chipset

<sup>1</sup> Floppy disk interrupt, INT6, is available for use if no floppy disk is present in the system and floppy disk is disabled in Setup.

<sup>2</sup> Hard disk interrupt, INT14, is available for use if no hard disk drive is present in the system and hard disk is disabled in Setup.

## ***The BIOS***

The BIOS (Basic Input/Output System) is software that interfaces hardware-specific features of the cpuModule to an operating system (OS). Physically, the BIOS software is stored in a Flash EPROM on the cpuModule. Functions of the BIOS are divided into two parts:

The first part of the BIOS is known as POST (Power-On Self-Test) software, and it is active from the time power is applied until an OS boots (begins execution). POST software performs a series of hardware tests, sets up the machine as defined in Setup, and begins the boot of the OS;

The second part of the BIOS is known as the CORE BIOS. It is the normal interface between cpuModule hardware and the operating system which is in control. It is active from the time the OS boots until the cpuModule is turned off. The CORE BIOS provides the system with a series of software interrupts to control various hardware devices.

The following sections discuss the sections of the BIOS in more detail and describe features of the BIOS which may be useful to you in developing applications.

## Power On Self Tests (POSTs)

When you turn on system power, the BIOS performs a series of tests and initializations. Each test or initialization step is identified by a numeric "POST" code written to I/O address 378H. These codes can be displayed using a commercially available "POST code display board". The following table lists the POST codes expressed in hexadecimal, with their corresponding meanings.

POST code list	
Code	Meaning
00H	CPU validation
01H	CPU test
02H	Component default programming
03H	Timer initialization
04H	Refresh line test
05H	BIOS EPROM test
06H	Keyboard controller test
07H	First 64K RAM test
08H	EEPROM test
09H	0F0000H-0FFFFFFH shadow memory test
0AH	DMA and interrupt controller initializations
0BH	Video device test
0CH	Timer #2 test
0DH	DMA controller #1 test
0EH	DMA controller #2 test
0FH	DMA page control registers test
10H	Interrupt controller #1 test
11H	Interrupt controller #2 test
12H	Shutdown byte test
13H	Interrupt line 0 test
14H	Keyboard test
15H	Protected-mode switch test
16H	Base memory size
17H	Expanded memory size
18H	Base memory test
19H	Expanded memory test
1AH	Co-processor test
1BH	Real Time Clock test
1CH	IRQ line test
1DH	Parallel port test
1EH	Floppy disk test
1FH	Hard disk test
20H	Serial port test
21H	Mouse test
22H	Shadow RAM test

## Errors While Booting

If an error occurs while the system is booting and performing the Power On Self Tests, the system will respond in one of several ways. Its response depends on what type of error occurred and on certain selections made in Setup.

Any error encountered in POST 1 through 7 causes the module to halt.

Errors encountered after POST 7 are dealt with according to settings made in Setup:

- With an error set to OFF in the Setup, a message is displayed on the screen and the speaker beeps. The boot continues if possible.
- With an error set to ON in the Setup, a message is displayed on the screen (if possible) and you are asked for confirmation before the boot continues.

If an error is detected in the EEPROM test (POST code 8) the system sets itself according to the default configuration presented in the following section. In that case, the system displays the detected errors and waits for confirmation before the boot continues.

When an error occurs and you are asked for confirmation to continue the boot, the {F1} key must be pressed to continue.

## Default Configuration

In addition to the Setup configuration stored on the board, the cpuModule has a permanent default configuration. The system will resort to using this default configuration in two situations:

- An error occurs when accessing the EEPROM which holds the Setup on the module.
- You force use of the default configuration, as explained in the following section.

The default configuration is listed below.

BIOS Default Configuration	
Function	Default selection
Chipset error	on
Hard disk 1	not installed
Hard disk 2	not installed
Boot device	Floppy
Floppy Drive 1	3.5" 1.44 MB
Floppy Drive 2	not installed
Floppy Error	off
Hard disk Error	off
Serial port 1	RS232 at 3F8H
Serial port 2	disabled
Keyboard	AT
Keyboard Error	off
Memory Error	on
Memory Size	16 MB
Parallel Port	LPT1 at 378H
384K remap	disabled
Real Time Clock Error	off
Shadow options	disabled
SSD socket 1	none
SSD window	D0000H
Video State	EGA/VGA
Video Error	off

## **Bypassing the Stored Configuration**

Under certain circumstances, you may want to bypass the configuration stored on the board. To do this:

- Insert jumper JP6. This will force the cpuModule to boot using the default configuration.
- Press the {Delete} key to enter Setup.

You can then reconfigure the cpuModule correctly using Setup.

See *Storing Applications On-board* on page 78 for the locations and functions of jumpers.

## ***BIOS Routines for Hardware Control***

The cpuModule BIOS provides several routines which you may find useful to control hardware in your application programs. Because they control hardware which is specific to this cpuModule, these routines are also specific to this cpuModule.

Routines are provided for:

- EEPROM Control
- Watchdog Timer Control

The following sections describe these functions in detail.

## EEPROM Control

The cpuModule is equipped with an EEPROM, or "Electrically Erasable and Programmable Read Only Memory". This part is primarily used to store the configuration from the Setup program. You can also use this part for non-volatile storage of a small amount of data. Its contents are retained even with system power off and no backup battery connected.

The EEPROM consists of 1024 bits organized as 64 words of sixteen bits each. Thirty-two words are used by the BIOS to store Setup information. The remaining 32 words are available to your applications. You may access these memory locations using functions of software interrupt 52H, which are listed below.

---

**NOTE!** The EEPROM will wear out after a large number of write cycles. You should *not* use the EEPROM to hold data which is updated frequently.

To prevent unintended changes to the Setup stored in the EEPROM, we recommend you always access the EEPROM using the interrupt functions listed below

---

<b>Function 0</b>	EEPROM write/erase enable. It is active until the next disable command and allows the device to be written and erased.
INPUTS:	AH = 0
RETURNS:	AH = error code
<b>Function 1</b>	EEPROM write/erase disable. This instruction must always be the last operation performed, to prevent undesired EEPROM access.
INPUTS:	AH = 1
RETURNS:	AH = error code
<b>Function 2</b>	EEPROM read. Reads from the device address specified in AL the number of words specified in CX, then stores the read values into the buffer addressed by ES:DI
INPUTS:	AH = 2 AL = address (0-3FH accepted) CX = number of words to read ES:DI = pointer to the buffer where the read values are stored
RETURNS:	AH = error code; if AH <> 0, then AL = number of locations read
<b>Function 3</b>	EEPROM write. Writes at the device address specified in AL, for the number of words specified in CX, the values pointed by DS:SI. Does not allow write operations at locations 0 to 1FH, which are reserved.

<b>INPUTS:</b>	AH = 3 AL = word address (20H-3FH accepted) CX = number of words to read DS:SI = pointer to the buffer where the read values are stored
<b>RETURNS:</b>	AH = error code; if AH<>0, then AL = number of locations written
<b>Function 4</b>	EEPROM verify. Verifies that the values contained in the device at the address specified by AL, for the number of words specified in CX, match the values in the buffer pointed to by ES:DI
<b>INPUTS:</b>	AH = 4 AL = word address (0-3FH accepted) CX = number of words to read ES:DI = pointer to the buffer where the read values are stored
<b>RETURNS:</b>	AH=error code if AH = FF, then AL = address where the compare failed
<b>Function 5</b>	EEPROM Erase. Erases words, starting from the address specified in AL, for the length specified in CX
<b>INPUTS:</b>	AH = 5 AL = word address (20H-3FH accepted) CX = number of words to read
<b>RETURNS:</b>	AH = error code; if AH<> 0, then AL= number of locations erased
<b>Error codes</b>	Errors detected by interrupt 52H are returned in register AH with the following code:
register AH:	00H no errors 10H access attempted to locations reserved by the BIOS 20H invalid address 40H illegal command 80H time-out FFH error in verify procedure

When you perform simple EEPROM read operations, you do not need to enable the EEPROM and can use the BIOS read command (function 2) directly.

When you perform EEPROM write operations, you must perform a correct write cycle as follows:

- enable the EEPROM
- erase the relevant locations
- write the relevant locations
- disable the EEPROM
- verify that the write operation has been correctly performed

An example BASIC program illustrating EEPROM access is in the file CMV\_EE.BAS on the cpu-Module utility disk.

## Watchdog Timer Control

The cpuModule includes a Watchdog Timer, which provides protection against programs "hanging", or getting stuck in an execution loop where they cannot respond correctly. When enabled, the Watchdog Timer must be periodically reset by your application program. If it is not reset before the timeout period of 1.2 seconds expires, it will cause a reset of the cpuModule.

Three functions have been implemented on the cpuModule for Watchdog Timer control. These are:

- Watchdog Timer enable
- Watchdog Timer disable
- Watchdog Timer reset

You may control the watchdog timer using functions of software interrupt 52H listed below.

<b>Function 0CH</b>	Watchdog Timer enable
INPUTS:	AH = 0CH
RETURNS:	None
<b>Function 0DH</b>	Watchdog Timer disable
INPUTS:	AH = 0DH
RETURNS:	None
<b>Function 0EH</b>	Watchdog Timer reset
INPUTS:	AH = 0EH
RETURNS:	None

## ***Direct Hardware Control***

Some of the cpuModule hardware is controlled directly without using BIOS routines. These include:

- Real Time Clock Control
- Parallel Port Control

The following sections describe use of these features.

## Real Time Clock Control

The cpuModule is equipped with a Real Time Clock (RTC) which provides system date and time functions, and also provides 64 non-volatile memory locations. The contents of these memory locations are retained whenever an external backup battery is connected, whether or not system power is connected. These locations are RAM, and do not wear out as the EEPROM locations do.

You may access the RTC date, time, and memory using an index and data register at I/O addresses 70h and 71h. Address 70h is the Index register. It must be written with the number of the register to read or write. Refer to the map below for valid choices for the index. Data is then written to or read from the selected register by writing or reading (respectively) the data register at address 71h.



Do *not* change values stored in the RTC registers listed as RESERVED in the table below. Doing so will interfere with proper cpuModule operation.

Registers of the Real Time Clock are shown below:.

Real Time Clock Registers			
Registers (hex)	Registers (decimal)	Number of Bytes	Function
00h	0	1	BCD Seconds
02h	2	1	BCD Minutes
04h	4	1	BCD Hours
06h	6	1	Day of week
07h	7	1	Day of month
08h	8	1	Month
09h	9	1	Year
0A-31h	10-49	40	<b>RESERVED- Do not modify!</b>
32h	50	1	BCD Century
33-3Fh	51-63	13	<b>RESERVED - Do not modify!</b>
40-7Fh	64-127	64	User RAM

RTC access is illustrated in the following QuickBasic program fragment:

```

input "Enter address to write:", i%
input "Enter value to write:", j%
output &h70, i%
output &h71, j%

output &h70, i%
j% = input (&h71)
print "Read back value ";i%;" at address ";j%
```

## **Parallel Port Control**

The parallel port may be operated in SPP (output-only) and bidirectional modes. The mode may be selected in Setup, or by application software.

An example BASIC program illustrating control and access to the parallel port is in file CMx\_PAR.BAS on the utility disk.

## **Processor Clock Control**

The processor clock can be programmed in the setup program. Further, the processor clock may be changed by a solder jumper on the back of the board. For 586DXLC133 boards, the switch is between clock-quadrupled and clock-tripled operation. For 486DXLC100 boards, the switch is between clock-tripled and clock-doubled operation. Please contact the factory for further information on implementing this change.

Please see *Power Consumption* on page 12 for a listing of Power Consumptions at different clock speeds.

## ***Storing Applications On-board***

The cpuModule was designed to be used in embedded computing applications. In these applications, magnetic media like hard disks and floppy disks are not very desirable. It is better to eliminate magnetic storage devices and place your operating system and application software into the cpuModule's Solid State Disk (SSD).

The following section describes two distinctly different ways you may use the Solid State Disk sockets of the cpuModule. These methods allow you to use a wide variety of memory devices to implement on-board Solid State Disk storage, each with its advantages and disadvantages.

## Ways to Use the Solid State Disk Sockets

There are two ways you may utilize the Solid State Disk sockets of the cpuModule.

- Using devices which install as BIOS Extensions
- Using Conventional SSD Memory

BIOS Extension Devices such as Disk On Chip and PromDisk provide a relatively large amount of read/write disk space in one socket of the cpuModule. These devices generally appear similar to a conventional hard disk to DOS, allowing you to copy, delete, and rename files without using any special utilities.

Conventional Solid State Disk uses a variety of memory devices, such as:

- Atmel 5 volt only Flash
- Intel 12 volt Flash
- AMD 5-volt Flash
- Static RAM
- NOVRAM
- EPROM

to create a Solid State Disk. When used with Atmel 5 volt Flash, SRAM or NOVRAM, the SSD appears similar to a read/write floppy disk to DOS, allowing you to copy, delete, and rename files in the SSD without using any special utilities.

When used with AMD 5-volt Flash or Intel 12V Flash, you can erase and program the SSD memory in the cpuModule using the SSD.EXE utility program.

These methods are described in detail in the following sections.

## BIOS Extension Devices

You can use BIOS Extension Devices like M-Systems DiskOnChip and MCSI PromDisk to implement a Solid State Disk which can be read and written using normal disk commands.

Advantages of using these devices include:

- Storage capacity up to 288 MB per socket (more in the future)
- Full read/write capability using standard OS file commands
- Integrated support for the QNX operating system is possible (contact M-Systems for information)

Disadvantages of using them include:

- Relatively high cost
- Current vendor software may allow only one device per cpuModule

Parts supported by the cpuModule include:

- M-Systems 2000 series: MD2200-D288 (288MB)  
down to...
- M-Systems 2000 series: MD2200-D02 (2MB)
- Optional QNX versions of the above parts
- MCSI PromDisk: 72300 (4MB)
- MCSI PromDisk: 72301 (8MB)

Our website at [www.rtdusa.com](http://www.rtdusa.com) provides links to the websites of these manufacturers.

## *Installing BIOS Extension Devices*

To install these devices, follow this procedure:

- Apply power to the cpuModule and run Setup. Select BIOS extension device for socket U9 or U10 in the Advanced Setup. Save your changes and exit Setup.
- Turn off the cpuModule.
- Set jumpers JP2 and JP3 or JP4 and JP5 to appropriate settings. Please see *SSD Jumpers* on page 97.
- Install the BIOS Extension Device into the correct socket.
- Reboot the cpuModule. The BIOS Extension Device should appear as the next available hard drive in your system. If there is no other hard drive installed, it will appear as drive C:.
- Format the new drive using the DOS format command.

---

**NOTE!** If you wish to make the drive bootable, you must format it using the /s switch of the format command. Refer to your OS manual for more information.

---

- If you wish to boot from the BIOS Extension Device, run Setup and disable any other hard drive. Set the boot device to Hard Drive. The cpuModule may not boot to a BIOS Extension Device if another hard drive is enabled.

## Conventional Solid State Disk

You can use numerous memory types to implement a Conventional Solid State Disk. Depending on the devices used, you may implement read/write, read-only, or write-once-read-many type drives.

Advantages of using the Conventional SSD include:

- Storage capacity up to 1 MB total (EPROM only)
- Allows mixing of device types
- Atmel Flash allows read/write capability using standard DOS file commands

Disadvantages of using the Conventional SSD include:

- Requires external utility program to program 12 volt Flash, AMD 5 Volt Flash, or EPROM.
- Requires external programmer to program EPROMs

The following memory devices or their equivalents may be used for a Conventional SSD. Access times for all devices must be 150 ns or less, and all devices *must* be in 32-pin DIP packages.

- Atmel 29C010A or 29C040A
- Intel 28F010 or 28F020
- AMD 29F010, 29F040
- SRAM 128Kx8, 512Kx8
- NOVRAM (Dallas Semiconductor DS1645Y, DS1650Y)

### EPROM (27C010, 27C020, 27C040, 27C080) *Installing a Conventional SSD using Atmel 5-volt-only Flash*

To install an SSD using Atmel Flash, follow this procedure:

- Apply power to the cpuModule and run Setup.
- If you are using the device in socket U1, set **SSD Device in U1** to the appropriate device type.
- Set **SSD Window** to a value which will not conflict with other hardware or software.

---

**NOTE!** The memory window selected for DOC must not be used by any other program or hardware device. Make sure this window is not in use by EMM386 or another memory manager, or an SSD, Ethernet card, PC-MCIA card, etc.

---

- Save your changes and exit Setup.
- Turn off the cpuModule.
- Set jumper JP1 to the appropriate setting. Please see *SSD Jumpers* on page 97.
- Install the memory device into the socket.
- Reboot the cpuModule. The SSD should appear as the next available drive in your system.
- Format the SSD using the DOS format command.

---

**NOTE!** If you wish to make the SSD bootable, you must format it using the /s switch of the format command. Refer to your DOS manual for more information on format.

When using the MS-DOS format command, always specify a size parameter. RTD recommends formatting all devices as 1.44 MB drives.  
format A: /f:1.44M

---

- If you wish to boot from the SSD, run Setup again and set the boot device to SSD.

### ***Installing a Conventional SSD using AMD 5-volt Flash***

AMD 5-volt Flash can be programmed either directly on the cpuModule or externally. If you wish to program Flash EPROMs externally, follow the steps listed for programming EPROMs. Otherwise, follow the steps below.

To program these Flash EPROMs on-board, the procedure is:

- Apply power to the cpuModule and run Setup.
- If you are using the device in socket U1, set **SSD Device in U1** to the appropriate device type.
- Set **SSD Window** to a value which will not conflict with other hardware or software.

---

**NOTE!** The memory window selected for DOC must not be used by any other program or hardware device. Make sure this window is not in use by EMM386 or another memory manager, or an SSD, Ethernet card, PCMCIA card, etc.

---

- Save your changes and exit Setup.
- Turn off the cpuModule.
- Set jumper JP1 to the appropriate setting. Please see **SSD Jumpers** on page 97.
- Install the memory devices into the correct sockets.
- On the cpuModule or another computer, format a floppy disk and copy onto it the files you wish to copy to the SSD. If you wish to boot from the SSD, you must format with the '/s' switch to copy system files. See your DOS manual for details of the format command.

---

**NOTE!** Start with a blank, newly-formatted disk each time you transfer files. You must copy files to the disk only one time, and must not delete, re-copy, or rename files on the floppy disk. If the files become fragmented, the process will not work!

---

- Apply power to the cpuModule.
- Run the SSD program on the cpuModule. Perform the menu selections appropriate for the chosen memory devices, then start programming.

After re-booting, the Solid State Disk will be seen by the system as a write-protected floppy. DOS commands normally used to read floppy disks will work with the SSD.

### ***Installing a Conventional SSD using SRAM or NOVRAM***

When the Solid State Disk is composed of SRAMs or NOVRAMs, it appears as a read/write disk and may be read and written using normal DOS disk commands.

To install an SRAM or NOVRAM SSD, you should follow this procedure:

- Apply power to the cpuModule and run Setup.
- If you are using the device in socket U1, set **SSD Device in U1** to the appropriate device type.

- Set **SSD Window** to a value which will not conflict with other hardware or software.

---

**NOTE!** The memory window selected for DOC must not be used by any other program or hardware device. Make sure this window is not in use by EMM386 or another memory manager, or an SSD, Ethernet card, PCMCIA card, etc.

---

- Save your changes and exit Setup.
- Turn off the cpuModule.
- Set jumper JP1 to the appropriate setting. Please see page *SSD Jumpers* on page 97.
- Install the memory device into the cpuModule socket.
- Reboot the cpuModule. The SSD should appear as the next available drive in your system.
- Format the SSD using the DOS format command.

If you wish to make the SSD bootable, you must format it using the /s switch of the format command. Refer to your DOS manual for more information on the format command.

If you wish to boot from the SSD, run Setup again and set the boot device to SSD.

### Notes on Formatting an SRAM or NOVRAM SSD

For most purposes, you can format the SRAM or NOVRAM SSD as you would a 1.44MB floppy, using a command line similar to:

*format b: /u*

To get the most possible space in the disk and ensure proper operation, use the format command with a size parameter just over the total size of the installed SSD memory. For example, if you install 256Kbytes of SRAM, you should use format with the parameters for a 360Kbyte floppy disk. For example:

ROM-DOS:*format b: /u /n:9 /t:40*

MS-DOS:*format b: /f:360K*

See your DOS manual for details on the format command and its parameters.

### Installing a Conventional SSD using EPROM

EPROMs for an SSD must be programmed externally to the cpuModule, using an EPROM programmer and following the procedure below.

To install an EPROM SSD, you should follow this procedure:

- Apply power to the cpuModule and run Setup.
- If you are using the device in socket U1, set **SSD Device in U1** to the appropriate device type.
- Set **SSD Window** to a value which will not conflict with other hardware or software.

---

**NOTE!** The memory window selected for DOC must not be used by any other program or hardware device. Make sure this window is not in use by EMM386 or another memory manager, or an SSD, Ethernet card, PCMCIA card, etc.

---

- Save your changes and exit Setup.

- On the cpuModule or another computer, format a floppy disk and copy onto it the files you wish to copy to the SSD. If you wish to boot from the SSD, you must format with the '/s' switch to copy system files. See your DOS manual for details of the format command.

---

**NOTE!** Start with a blank, newly-formatted disk each time you transfer files. You must copy files to the disk only one time, and must not delete, re-copy, or rename files on the floppy disk.

---

- Boot the cpuModule and start the SSD program. Select settings appropriate for the chosen EPROMs.
- Select the Binary File "construct" option and then Start execution; the program will create an EPROMx.BIN file for each EPROM.
- Use the EPROMx.BIN file created to program EPROMs with an appropriate EPROM programmer.
- With the cpuModule off, set jumper JP1 to the appropriate settings for the EPROM you are using. Please see *SSD Jumpers* on page 97.
- Boot the cpuModule.

After booting, the Solid State Disk will be seen by the system as a write-protected floppy. DOS commands normally used to read floppy disks will work with the SSD.

### ***Directly Accessing the Solid State Disk***

If you wish to directly access the Solid State Disk of the cpuModule, you may do so using an extension to interrupt 52H.

Contact the factory for additional information on doing so.

## Using Virtual Devices

The cpuModule is designed for use in industrial environments as a stand-alone module, without external peripherals. Nevertheless, it may be necessary to interface a cpuModule with I/O devices like a keyboard, monitor, or floppy or hard drive, especially for set-up or maintenance.

The cpuModule is therefore provided with "Virtual Devices", which allows you to access a keyboard, monitor, and floppy disks without directly connecting them to the PC/104 bus of the module. Instead, the cpuModule serial port is connected to the serial port of a PC or AT "host" computer. The host computer's keyboard, monitor, and floppy disks can then be made available to the cpuModule. You can then boot from the host's floppy drives, edit and debug programs using the host's keyboard and monitor, and so on.

---

**NOTE!** Virtual Devices mode is intended for use during development, testing, and servicing of the cpuModule. It is *not* intended for use during normal operation of the cpuModule. The overhead required by Virtual Devices will probably cause unacceptable performance while running an application.

If you require user I/O through the serial port, we strongly recommend you implement your own serial I/O or use a commercial software product intended for this purpose.

---

There are two limitations when using Virtual Device mode:

- programs must operate only in text mode
- program screen input/output must use only BIOS calls

Applications which use graphics modes or directly access hardware (video memory, the keyboard, or the disk drives) will not work properly.

To use Virtual Devices mode, you will need:

- a PC or AT compatible "host" computer with a serial port
- the connection program (SERRX.EXE) available on the host computer
- a "null-modem" cable with the transmit data, receive data, and ground pins connected the cpuModule

There are two ways to initiate Virtual Device mode. You can enable the mode by using the cpuModule Setup program, or by jumpering pins on the first serial port connector of the cpuModule. Please note that behavior differs slightly depending on how Virtual Device mode is initiated. The following sections discuss the two methods.

## **Initiating Virtual Devices from Setup**

If the cpuModule is operational, Virtual Device mode can be accessed from Setup. This method has the advantage that you can individually select devices for use in Virtual Devices mode. To use this method, run Setup on the cpuModule and select the Virtual Devices you wish to use. The settings for floppy drive A:, keyboard, and video state, and hard disk C: can each be set to "serial". Save your changes and then follow the procedure below:

- 1) Turn off power to the cpuModule system.
- 2) Connect the null modem cable between the cpuModule and host computer.
- 3) Turn on the host computer.
- 4) Start the SERRX.EXE program on the host computer, specifying which serial port of the host computer you wish to use.
- 5) Turn on the cpuModule system.

The cpuModule system will now boot from the disk drive you configured in Setup. If you have a C: disk on the PC/104 system, it will be drive D:.

## Initiating Virtual Devices by Jumpering Serial Port Pins

Virtual Device mode can also be initiated by shorting two pins on the first or second serial port connector of the cpuModule. This method has a slight disadvantage in that the keyboard, video, and floppy and hard drives are all redirected to the serial port. To use this method, you must short (connect) two pins on the first serial port connector. The exact procedure is:

- Turn off power to the cpuModule system.
- Make certain the serial port of the cpuModule is configured for RS-232 operation. If the port is set for RS-422 or RS-485 operation, you cannot start Virtual Devices mode by jumpering serial port pins.
- Carefully connect the RI and DTR pins (7 and 8) of the serial port connector (refer to the chapter on Connecting the cpuModule for pin locations).
- Connect the null modem cable between the cpuModule and the host computer.
- Turn on the host computer.
- Start the SERRX.EXE program on the host computer, specifying which serial port of the host computer you wish to use.
- Turn on the cpuModule system.

The cpuModule system will then boot from the host computer's disk drives. The drive it boots from will be the one selected in Setup. Note that if both the PC/104 system and the host computer have C: disks, the one on the host computer's remains disk C:, while the one on the cpuModule becomes available as drive D:.

## **Disconnecting the Host Computer**

To disconnect the host computer, press the {Prt Scrn} key at any time. The host computer will recover its peripherals and returns to normal operation.

To re-connect the cpuModule to the host, re-run SERRX.EXE on the host and wait for the message:

**Waiting .....**

and then press the {Return} or {Enter} key.

## **Notes when Using Virtual Device Mode**

You will find it useful to remember the following points when using Virtual Devices:

Large data transfers (file accesses, display updates, etc.) take considerable time in Virtual Device mode. Please be patient.

When you make the keyboard a Virtual Device, the key combination CTRL-ALT-DEL is not passed to the cpuModule; it resets the host computer instead.

When you make floppy drive A: a Virtual Device, both A: and B: floppy disks are actually redirected to the host computer.

If a communication error occurs on the serial port link, you will hear a beep from both the host computer and the cpuModule (assuming speakers are present in both systems).

## ***Utility Programs***

The cpuModule is supplied with several utility programs needed for programming a Conventional SSD or reprogramming the BIOS. The following sections discuss these utilities in detail.

## Solid State Disk Utility (SSD.EXE)

The Solid State Disk utility program (SSD.EXE) allows you to program applications into 12 volt Flash or conventional EPROMs for use in a Conventional Solid State Disk. It is supplied on the cpu-Module utility floppy disk. Use of the program is described below.

### Available Options

The SSD program screen is divided into two areas:

- the upper part contains user-selectable fields
- the lower part contains help messages and displays program output

Once you make selections, you can:

- start executing the program, by pressing the {S} key
- quit the program, by pressing the {Q} key.

### Field Selection

You can make selections using the keys listed in the following table.

SSD Active Keys	
Key	Function
↓	selects next field
↑	selects previous field
{TAB}	selects next field to the right or first field of next line
←	selects next value in field
→	selects previous value in field

### Contents of the Fields

The following is a list of selectable fields in the SSD program:

Selectable Fields		
Field	Active keys	Selections
Binary Files	← →	<p>Enables creation of binary files (EPROMx.BIN) needed to program EPROMs for the Solid State Disk.</p> <p>Selections:</p> <ul style="list-style-type: none"><li>• Construct</li><li>• None</li></ul> <p>The program creates the .bin files in the directory from which it is run. When working with a single floppy <b>do not</b> enable the Construct option.</p>

Devices Dimension	← →	<p>Selects the size of each memory device for the SSD.</p> <p>Possible selections:</p> <ul style="list-style-type: none"> <li>• Flash (128k, 256k)</li> <li>• EPROM (128k, 256k, 512k, 1Mbyte)</li> <li>• RAM (128k, 512k)</li> </ul> <p>Select a setting which agrees with the installed memory devices and the positions of jumper JP1.</p>
Devices Number	← →	<p>Selects the number of memory devices for the SSD.</p> <p>Possible selections:</p> <ul style="list-style-type: none"> <li>• One</li> <li>• Two (Use only with CMV family)</li> </ul>
Devices Type	← →	<p>Selects the type of memory devices used to implement the Solid State Disk.</p> <p>Possible selections:</p> <ul style="list-style-type: none"> <li>• Flash</li> <li>• EPROM</li> </ul> <p>If EPROM is selected, the binary files <i>construct</i> mode is automatically enabled.</p>
Input File	← → {TAB},{char}	<p>Defines the name of the input file in MiniDOS or BIOS Extension mode. In MiniDOS mode, the filename must have the extension .EXE.</p>
MiniDOS option	← →	<p>Selects either MiniDOS or BIOS Extension mode.</p>
Source Disk	← →	<p>Selects the floppy you wish to have copied into the SSD.</p>
SSD Window	← →	<p>Selects the 16KB memory window used for the SSD.</p> <p>Selections are</p> <ul style="list-style-type: none"> <li>• from 0C0000H</li> <li>• to 0EC000H</li> </ul> <p>by 32KB steps.</p> <p>This window is used only when programming the SSD in the cpuModule socket(s).</p> <p>It must not be in use by any other device.</p>

## **BIOS Build Utility (ATBIOSPR.EXE)**

The BIOS Build utility program, ATBIOSPR.EXE, allows you to re-program the BIOS.

Incorrectly programming the BIOS can completely halt operation of the cpuModule, requiring it to be returned to the factory. Do not attempt to reprogram the BIOS unless you fully understand the procedure.

### ***BIOS Organization***

The cpuModule BIOS is in a 128k byte Flash EPROM. The ROM is at addresses E0000H through FFFFFH.

The first 64kbytes, from E0000H to EFFFFH, contains the Setup program which is executed when the {Delete} key is held during boot. The upper 64kbytes, from F0000H to FFFFFH, contains the normal PC BIOS of the cpuModule.

### ***Using BIOSBLD***

The Program is run by entering the following command line:

```
ATBIOSPR <file_name> 1 24
```

where:

<file\_name>:Name of the file to be programmed into the Flash EPROM.

Example:

To reprogram the BIOS with the file MYROM.400 (which is 128KB long), you would use the command line:

```
ATBIOSPR MYROM.400 1 24
```



# CHAPTER 6: HARDWARE REFERENCE

This appendix gives information on the cpuModule hardware, including:

- jumper settings and locations
- solder jumper settings and locations
- mechanical dimensions
- processor thermal management

## Jumpers

The figure below shows the locations of the jumpers used to configure the cpuModule. To use the figure, position the module with the PC/104 bus connector at the six o'clock position and the component side facing up. The table below lists the jumpers and their settings.

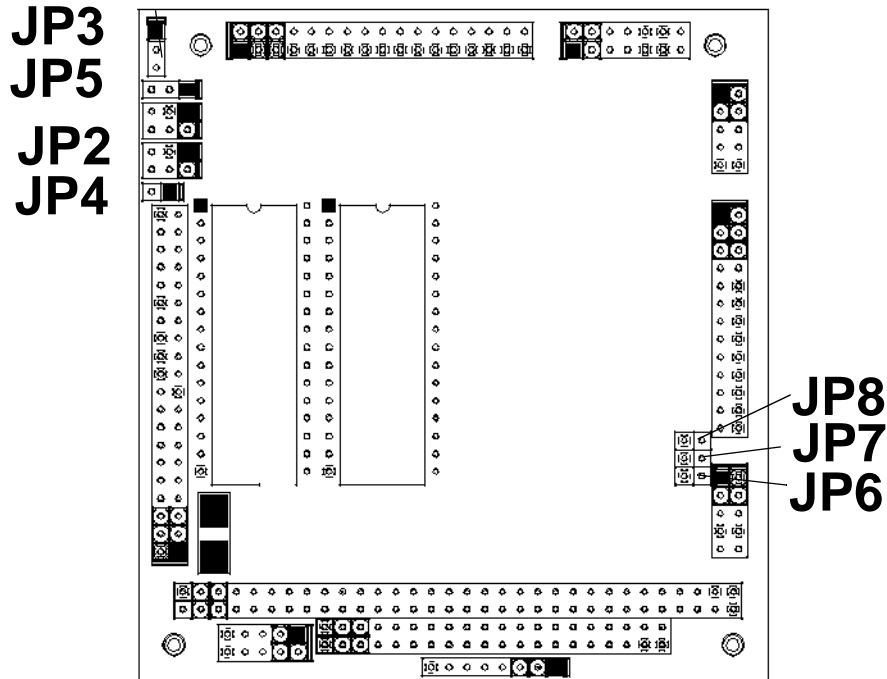

Jumper	Use
JP2 & JP3	U9 SSD Jumpers, See SSD device table for settings
JP4 & JP5	U10 SSD Jumpers, See SSD device table for settings
JP6	2-pin jumper Open: force cpuModule to use permanent default settings stored in BIOS; normal operation Closed: Forces use of factory default configuration Factory Default: Closed
JP6	Factory use only; do not close.
JP8	2-pin jumper Open: E0000 - EFFFF memory location mapped to lower 64KB of BIOS EPROM. Closed: E0000 - EFFFF memory location mapped to PC/104 Bus. Factory Default: Closed, E000 segment mapped to PC/104 bus

## SSD Jumpers

### *Installing SSD Memory in U9*

You may wish to install SSD memory to use the cpuModule as a "diskless" stand-alone device.

Refer to *Ways to Use the Solid State Disk Sockets* on page 79 for more information on various SSD device types. Solid State Disk memories are placed in socket U1.

The following table lists possible configurations for the SSD socket:

SSD Devices in U9						
Type	Part	Operation	Capacity	JP2	JP3	Notes
Atmel 5V Flash	29C010A	read/write	128KB	3-4	1-2	
	29C040A	read/write	512KB	1-2	1-2	
BIOS Extension Devices	DiskOnChip and PromDisk	read/write	to 288MB+	1-2	1-2	
SRAM	128KB	read/write	128KB	3-4	1-2	no backup
				3-4	2-3	battery backup
	512KB	read/write	512KB	1-2	1-2	no backup
				1-2	2-3	battery backup
NOVRAM	DS1645Y	read/write	128KB	3-4	1-2	
	DS1650Y	read/write	512KB	1-2	1-2	
12V Flash	28F010	read-only	128KB	3-4	1-2	read-only
				5-6	1-2	Programming with SSD.EXE
	28F020	read-only	256KB	3-4	1-2	read-only
				5-6	1-2	Programming with SSD.EXE
AMD 5V Flash	29F010	read-only	128KB	3-4	1-2	program or read
	29F040	read-only	512KB	1-2	1-2	program or read
EPROM	27C010	read-only	128KB	3-4	1-2	read only
	27C020	read-only	256KB	3-4	1-2	read only
	27C040	read-only	512KB	1-2	1-2	read only
	27C080	read-only	1MB	1-2	1-2	read only

### *Installing SSD Memory in U10*

You may wish to install SSD memory to use the cpuModule as a "diskless" stand-alone device.

Refer to *Ways to Use the Solid State Disk Sockets* on page 79 for more information on various SSD device types. Solid State Disk memories are placed in socket U1.

The following table lists possible configurations for the SSD socket:

SSD Devices in U10						
Type	Part	Operation	Capacity	JP4	JP5	Notes
Atmel 5V Flash	29C010A	read/write	128KB	3-4	1-2	
	29C040A	read/write	512KB	1-2	1-2	
BIOS Extension Devices	DiskOnChip and PromDisk	read/write	to 288MB+	1-2	1-2	
SRAM	128KB	read/write	128KB	3-4	1-2	no backup
				3-4	2-3	battery backup
	512KB	read/write	512KB	1-2	1-2	no backup
				1-2	2-3	battery backup
NOVRAM	DS1645Y	read/write	128KB	3-4	1-2	
	DS1650Y	read/write	512KB	1-2	1-2	
12V Flash	28F010	read-only	128KB	3-4	1-2	read-only
				5-6	1-2	Programming with SSD.EXE
	28F020	read-only	256KB	3-4	1-2	read-only
				5-6	1-2	Programming with SSD.EXE
AMD 5V Flash	29F010	read-only	128KB	3-4	1-2	program or read
	29F040	read-only	512KB	1-2	1-2	program or read
EPROM	27C010	read-only	128KB	3-4	1-2	read only
	27C020	read-only	256KB	3-4	1-2	read only
	27C040	read-only	512KB	1-2	1-2	read only
	27C080	read-only	1MB	1-2	1-2	read only

## Solder Jumpers

Solder jumpers are set at the factory and normally you will not need to change them. All solder jumpers are located on the module's solder side. The diagram below shows the locations of the solder jumpers. To use the diagram, position the module with the PC/104 bus connector at the six o'clock position and the solder side facing up..

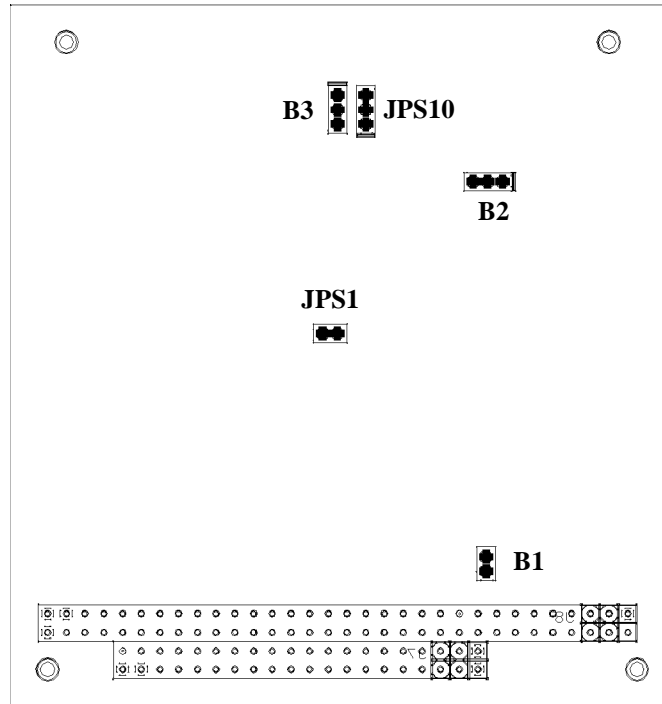

The following table lists the solder jumpers and their settings.

B1, B2, B3, JPS1	Solder jumpers Reserved for factory use. Leave as set.
JPS10	3-pad jumper Selects clock-multiplier for processor. For 5x86DXLC133: 1-2: clock-quadrupled 2-3: clock-tripled For 486DXLC100: 1-2: clock-doubled 2-3: clock-tripled Defaults: 1-2 for 5x86DXLC133 or 486DXLC66; 2-3 for 486DXLC100

## Mechanical Dimensions

The following figure shows mechanical dimensions of the module (in inches).

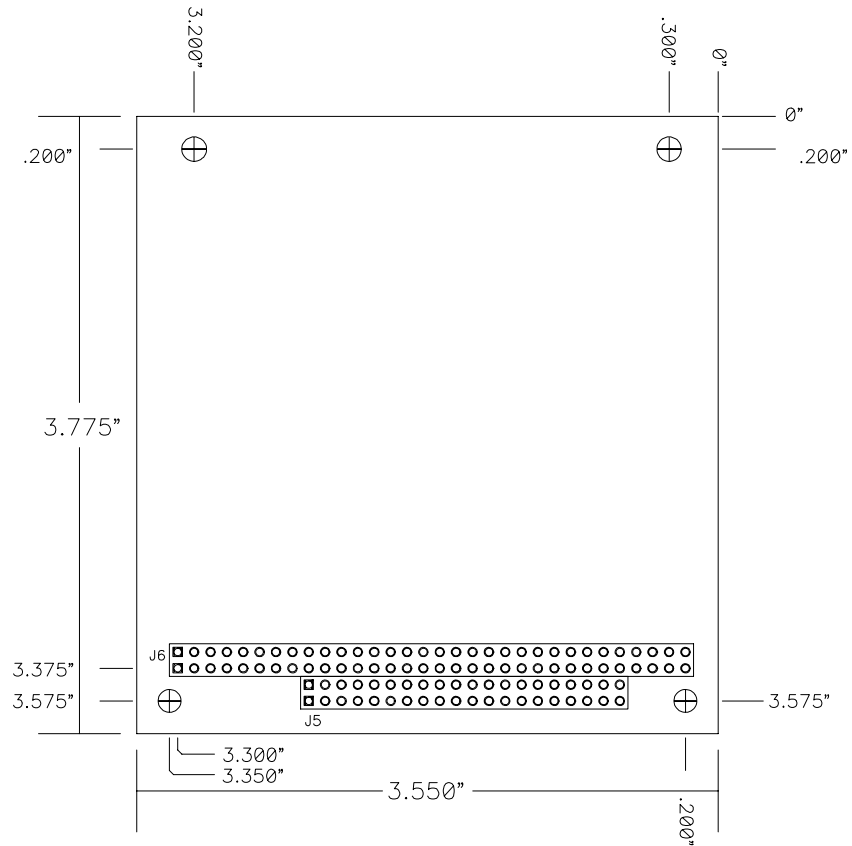

**Mechanical Dimensions (+/- 0.005")**

## 486DX100/66 Processor Thermal Management

The industrial grade processor IC of the cpuModule must receive adequate cooling to ensure proper operation and good reliability. The processor is therefore supplied with an attached heatsink.

---

**NOTE!** This cpuModule is *not* warranted against damage caused by overheating due to improper or insufficient heatsinking or airflow.

---

The table below shows the maximum ambient temperature allowed.

Maximum Allowable Ambient Temperature	
Without heat sink	70 C
With heat sink	86 C
With heat sink and fan	98 C

Values shown are valid for all possible clock frequencies.

## 5x86DX133 Processor Thermal Management

The processor IC of the cpuModule must receive adequate cooling to ensure proper operation and good reliability. The processor is therefore supplied with an attached heatsink.

---

**NOTE!** This cpuModule is *not* warranted against damage caused by overheating due to improper or insufficient heatsinking or airflow.

---

The table below shows the maximum ambient temperature allowed at various airflows while preventing damage to the processor.

Maximum Allowable Ambient Temperature	
Without heat sink	45 C
With heat sink	66 C
With heat sink and fan	82 C

Values shown are valid for all possible clock frequencies.

# CHAPTER 7: TROUBLESHOOTING

Many problems you may encounter with operation of your cpuModule are due to common errors. This chapter will help you get your system operating properly.

It contains:

- Common problems and solutions
- Troubleshooting a PC/104 system
- How to obtain technical support
- How to return a product

## Common Problems and Solutions

The following table lists some of the common problems you may encounter while using your cpuModule, and suggests possible solutions.

If you are having problems with your cpuModule, please review this table *before* contacting technical support.

Problem	Cause	Solution
cpuModule "will not boot"	no power or wrong polarity	check for correct power on PC/104 bus connectors
	incorrect Setup (video disabled, etc.)	install jumper JP6; reboot and press {Delete} key to run Setup
	defective or mis-connected device on bus	check for misaligned bus connectors; remove other cards from stack
	cable connected backwards	verify all cables are connected correctly
	SSD installed backwards	check for an SSD memory installed in socket backwards
	entering Virtual Devices mode	check if first or second serial port is jumpered to force Virtual Devices mode
does not recognize Setup changes	jumper JP6 installed	turn off power, remove JP6, reboot
Setup always runs at boot, whether or not {Delete} key is held	E000 segment mapped to BIOS ROM	Enter Advanced Setup screen, change E000 Segment Map to 'PC/104 Bus'
will not boot from particular drive or device	device not bootable	use sys command on drive or re-format the device using the /s switch
	device not formatted	format drive using /s switch
	power not connected to boot drive	connect power cable to floppy or hard drive
"General Failure..." message attempting to access Atmel Flash in SSD	jumpers incorrectly set	set SSD jumpers correctly; see Jumper Setting tables for SSD; Note: if device was formatted with jumpers set incorrectly, it <i>must</i> be re-formatted
Added second Atmel Flash to SSD; will not re-format to larger size	format command must have size specified	execute format command with <b>/f:1.44</b> switch
Atmel Flash shows disk space available, but it cannot be written	part smaller than 1.44MB was formatted as 1.44MB; it will show space available even when full	ignore "disk space remaining" messages from DOS <b>REMEMBER!</b> A bootable disk contains 3 hidden files plus format info, totalling about 150kB

will not boot from DiskOnChip	DiskOnChip is not the only hard drive in system	disable other hard drive(s) in system or use M-Systems DUPDATE utility with / FIRST option.
	using wrong DiskOnChip device (not 32 pin)	change to correct (32 pin) DiskOnChip
	Boot device not set to Hard disk	run Setup and set boot device to Hard Drive
erratic operation	excessive bus loading	reduce number of PC/104 modules in stack; remove termination components from bus signals
	power supply noise	examine power supply output with oscilloscope; glitches below 4.75Vdc will trigger a reset; add bypass caps
	power supply limiting	examine power supply output with oscilloscope; check for voltage drop below 4.75V when hard drive or floppy drive starts; add bypass caps
	temperature too high	add fan, processor heatsink, or other cooling device(s)  <i>See 486DX100/66 Processor Thermal Management on page 101.</i>
	memory address conflict	check for two hardware devices (e.g. Ethernet, SSD, Arcnet, PCMCIA) trying to use the same memory address  check for two software devices (e.g. EMM386, PCMCIA drivers, etc.) trying to use the same memory addresses  check for hardware and software devices trying to use the same memory address  check for an address range shadowed (see Advanced Setup screen) while in use by another hardware or software device
	I/O address conflict	check for another module trying to use I/O addresses reserved for the cpuModule between 010h and 01Fh  check for two modules (e.g. dataModules, PCMCIA cards, Ethernet) trying to use the same I/O addresses
Will not enter Virtual Devices mode	correct pins not jumpered	jumper pins 7&8 (RI and DTR) of first or second serial port
	port configured for RS422 or RS485	configure serial port for RS232

	incorrect cable	cable must 'criss-cross' TXD and RXD lines from end to end
keyboard does not work	keyboard interface damaged by misconnection	check if keyboard LEDs light
	wrong keyboard type	verify keyboard is an 'AT' type or switch to 'AT' mode
Windows 3.1x installation program hangs	smartdrive enabled	remove smartdrive command from config.sys, reboot, run install program
floppy drive light always on	cable misconnected	check for floppy drive cable connected backwards
two hard drives will not work, but one does	both drives configured for master	set one drive for master and the other for slave operation (consult drive documentation)
floppy does not work	"data error" due to drive upside down	orient drive properly (upright or on its side)
will not boot when video card is removed	illegal calls to video controller	look for software trying to access non-existent video controller for video, sound, or beep commands
won't boot from PCMCIA hard drive	booting from PCMCIA is not supported	boot from SSD, use autoexec.bat to load PCMCIA drivers, run application from PCMCIA card or use RTD's CMT104 which accesses PCMCIA ATA drives as an IDE drive.
COM port will not work in RS422 or RS485 modes	not configured for RS422/485	correctly configure serial port in Setup program
COM port will not transmit in RS422 or RS485 mode	not enabling transmitters	control RTS* bit of Modem Control Register to enable transmitters; see Serial Port descriptions
date and time not saved when power is off	no backup battery	connect a backup battery to the Multifunction connector

## **Troubleshooting a PC/104 System**

If you have reviewed the preceding table and still cannot isolate the problem with your cpuModule, please try the following troubleshooting steps. Even if the resulting information does not help you find the problem, it will be very helpful if you contact technical support.

**Simplify the system.** Remove items one at a time and see if one particular item seems to cause the problem.

**Swap components.** Try replacing items in the system one-at-a-time with similar items.

## How to Obtain Technical Support

If after following the above steps, you still cannot resolve a problem with your cpuModule, please assemble the following information:

- cpuModule **model**, **BIOS version**, and serial number
- list of **all boards in system**
- list of settings from cpuModule Setup program
- printout of autoexec.bat and config.sys files (if applicable)
- description of problem
- circumstances under which problem occurs

Then contact factory technical support:

Phone: 814 234-8087  
Fax: 814 234-5218  
E-mail: techsupport@rtdusa.com

## How to Return a Product

---

**NOTE!** You *must* have authorization from the factory before returning *any* item for *any* reason!

---

If you wish to return a product to the factory for service, please follow this procedure:

- 1) Read the Limited Warranty to familiarize yourself with our warranty policy.
- 2) Contact the factory for a Return Merchandise Authorization (RMA) number.
- 3) **Write a detailed description** of the situation or problem.  
Include as much information as possible!
- 4) **List the name of a contact person**, familiar with technical details of the problem or situation, **along with their phone and fax numbers, address, and e-mail address** (if available).
- 5) **List your shipping address!!**
- 6) Indicate the shipping method you would like used to return the product to you.  
*We will not ship by next-day service without your pre-approval.*
- 7) Carefully package the product, *using proper anti-static packaging.*
- 8) Write the RMA number in large (1") letters on the outside of the package.
- 9) Return the package to:

Real Time Devices  
200 Innovation Blvd.  
State College PA 16803  
USA



## CHAPTER 8: LIMITED WARRANTY

Real Time Devices, Inc. warrants the hardware and software products it manufactures and produces to be free from defects in materials and workmanship for one year following the date of shipment from REAL TIME DEVICES. This warranty is limited to the original purchaser of product and is not transferable.

During the one year warranty period, REAL TIME DEVICES will repair or replace, at its option, any defective products or parts at no additional charge, provided that the product is returned, shipping prepaid, to REAL TIME DEVICES. All replaced parts and products become the property of REAL TIME DEVICES. Before returning any product for repair, customers are required to contact the factory for an RMA number.

THIS LIMITED WARRANTY DOES NOT EXTEND TO ANY PRODUCTS WHICH HAVE BEEN DAMAGED AS A RESULT OF ACCIDENT, MISUSE, ABUSE (such as: use of incorrect input voltages, improper or insufficient ventilation, failure to follow the operating instructions that are provided by REAL TIME DEVICES, "acts of God" or other contingencies beyond the control of REAL TIME DEVICES), OR AS A RESULT OF SERVICE OR MODIFICATION BY ANYONE OTHER THAN REAL TIME DEVICES. EXCEPT AS EXPRESSLY SET FORTH ABOVE, NO OTHER WARRANTIES ARE EXPRESSED OR IMPLIED, INCLUDING, BUT NOT LIMITED TO, ANY IMPLIED WARRANTIES OF MERCHANTABILITY AND FITNESS FOR A PARTICULAR PURPOSE, AND REAL TIME DEVICES EXPRESSLY DISCLAIMS ALL WARRANTIES NOT STATED HEREIN. ALL IMPLIED WARRANTIES, INCLUDING IMPLIED WARRANTIES FOR MERCHANTABILITY AND FITNESS FOR A PARTICULAR PURPOSE, ARE LIMITED TO THE DURATION OF THIS WARRANTY. IN THE EVENT THE PRODUCT IS NOT FREE FROM DEFECTS AS WARRANTED ABOVE, THE PURCHASER'S SOLE REMEDY SHALL BE REPAIR OR REPLACEMENT AS PROVIDED ABOVE. UNDER NO CIRCUMSTANCES WILL REAL TIME DEVICES BE LIABLE TO THE PURCHASER OR ANY USER FOR ANY DAMAGES, INCLUDING ANY INCIDENTAL OR CONSEQUENTIAL DAMAGES, EXPENSES, LOST PROFITS, LOST SAVINGS, OR OTHER DAMAGES ARISING OUT OF THE USE OR INABILITY TO USE THE PRODUCT.

SOME STATES DO NOT ALLOW THE EXCLUSION OR LIMITATION OF INCIDENTAL OR CONSEQUENTIAL DAMAGES FOR CONSUMER PRODUCTS, AND SOME STATES DO NOT ALLOW LIMITATIONS ON HOW LONG AN IMPLIED WARRANTY LASTS, SO THE ABOVE LIMITATIONS OR EXCLUSIONS MAY NOT APPLY TO YOU.

THIS WARRANTY GIVES YOU SPECIFIC LEGAL RIGHTS, AND YOU MAY ALSO HAVE OTHER RIGHTS WHICH VARY FROM STATE TO STATE.

