



ADP086-1

ADP086-2

*USB 3.0 and SATA Adapter
for PCIe/104 and PCI/104-Express Type 2*

User's Manual

BDM-610040013 Rev. A

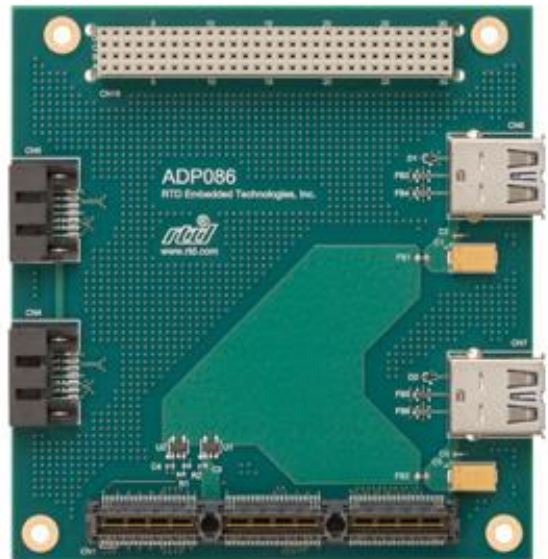

RTD Embedded Technologies, Inc.

103 Innovation Boulevard
State College, PA 16803 USA
Telephone: 814-234-8087
Fax: 814-234-5218

www.rtd.com

sales@rtd.com
techsupport@rtd.com



Revision History

Rev A Initial Release

Advanced Analog I/O, Advanced Digital I/O, aAIO, aDIO, a2DIO, Autonomous SmartCal, "Catch the Express", cpuModule, dspFramework, dspModule, expressMafe, ExpressPlatform, HiDANplus, "ML Value for COTS prices", multiPort, PlatformBus, and PC/104EZ are trademarks, and "Accessing the Analog World", dataModule, IDAN, HiDAN, RTD, and the RTD logo are registered trademarks of RTD Embedded Technologies, Inc (formerly Real Time Devices, Inc.). PS/2 is a trademark of International Business Machines Inc. PCI, PCI Express, and PCIe are trademarks of PCI-SIG. PC/104, PC/104-Plus, PCI-104, PCIe/104, PCI/104-Express and 104 are trademarks of the PC/104 Embedded Consortium. All other trademarks appearing in this document are the property of their respective owners.

Failure to follow the instructions found in this manual may result in damage to the product described in this manual, or other components of the system. The procedure set forth in this manual shall only be performed by persons qualified to service electronic equipment. Contents and specifications within this manual are given without warranty, and are subject to change without notice. RTD Embedded Technologies, Inc. shall not be liable for errors or omissions in this manual, or for any loss, damage, or injury in connection with the use of this manual.

Copyright © 2015 by RTD Embedded Technologies, Inc. All rights reserved.

Table of Contents

1	Introduction	6
1.1	Product Overview.....	6
1.2	Board Features	6
1.3	Ordering Information.....	6
1.4	Contact Information	7
1.4.1	Sales Support	7
1.4.2	Technical Support	7
2	Specifications	8
2.1	Operating Conditions	8
2.2	Electrical Characteristics	8
3	Board Connection	9
3.1	Board Handling Precautions	9
3.2	Physical Characteristics.....	9
3.3	Connectors and Jumpers.....	10
3.3.1	External I/O Connectors	10
	CN6 & CN7: USB 3.0 Connectors	10
	CN4 & CN5: SATA Connectors	11
3.3.2	Bus Connectors	11
	CN1 (Top) & CN2 (Bottom): PCIe Connector	11
	CN3: PCI Connector (ADP086-2 only)	11
3.4	Selecting the Stack Order for the ADP086	11
3.5	Steps for Installing	12
4	Functional Description	13
4.1	Functional Diagram.....	13
4.2	Backwards Compatibility with USB 2.0.....	13
4.3	Power.....	13
5	Troubleshooting	14
6	Additional Information	15
6.1	PC/104 Specifications.....	15
6.2	PCI and PCI Express Specification	15
7	Limited Warranty	16

Table of Figures

Figure 1: ADP086-1	6
Figure 2: ADP086-2	6
Figure 3: Board Dimensions (inches)	9
Figure 4: Board Connections	10
Figure 5: Example 104™ Stack	12
Figure 6: ADP086 Functional Diagram	13

Table of Tables

Table 1: Ordering Options	6
Table 2: Operating Conditions	8
Table 3: Electrical Characteristics	8
Table 4: USB Port Connections	10
Table 5: SATA Port Connections	11

1 Introduction

1.1 Product Overview

The ADP086 is a rugged dual-port USB 3.0 and SATA adapter for host modules which provides these connections on a downward stacking PCIe/104 Type 2 bus. This adapter breaks out the USB 3.0 and SATA data connections on the bus connector for easy cabled accessibility, while adhering to the stacking requirements of PC/104, allowing easy integration into a PC/104 system.

The USB 3.0 links on the ADP086 are backwards compatible with USB 2.0, permitting breakout of all USB ports on the host's bottom-side PCIe/104 Type 2 bus. The ADP086's utilization of a host's PCIe/104 USB links avoids bandwidth starvation of the host's primary USB I/O connections, making this module a useful accessory to any of RTD's Intel Core i7, AMD Fusion G-Series, and Intel Core 2 Duo, and Intel Celeron M single board computers.

1.2 Board Features

- PCIe/104 stackable bus structure (ADP086-1)
 - PCIe/104 Type 2 Connectors
- PCI/104-Express stackable bus structure (ADP086-2)
 - PCIe/104 Type 2 Connectors
 - Pass-through PCI bus
- Dual-port USB 3.0 breakout
 - Provides access to both USB 3.0 links available on a host's down-stacking PCIe/104 Type 2 connector
 - Backwards compatible with USB 2.0
- Dual SATA data connectors
 - Provides access to both SATA links available on a host's down-stacking PCIe/104 Type 2 connector
- Stacks below the host cpuModule

1.3 Ordering Information

The ADP086 is available with the following options:

Table 1: Ordering Options

Part Number	Description
ADP086-1	PCIe/104 Type 2
ADP086-2	PCI/104-Express Type 2

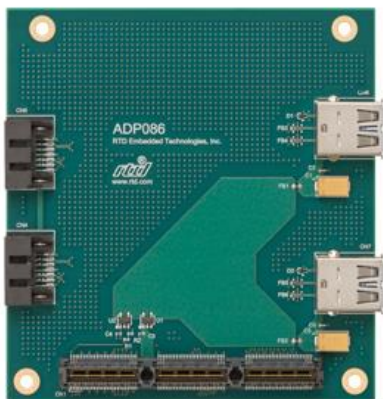

Figure 1: ADP086-1

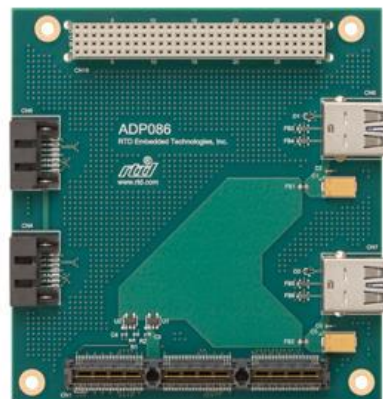

Figure 2: ADP086-2

1.4 Contact Information

1.4.1 SALES SUPPORT

For sales inquiries, you can contact RTD Embedded Technologies sales via the following methods:

Phone: 1-814-234-8087 Monday through Friday, 8:00am to 5:00pm (EST).
E-Mail: sales@rtd.com

1.4.2 TECHNICAL SUPPORT

If you are having problems with you system, please try the steps in the Troubleshooting section of this manual.

For help with this product, or any other product made by RTD, you can contact RTD Embedded Technologies technical support via the following methods:

Phone: 1-814-234-8087 Monday through Friday, 8:00am to 5:00pm (EST).
E-Mail: techsupport@rtd.com

2 Specifications

2.1 Operating Conditions

Table 2: Operating Conditions

Symbol	Parameter	Test Condition	Min	Max	Unit
V _{cc5}	5V Supply Voltage		4.75	5.25	V
V _{cc5-STBY} ¹	5V Standby Voltage		4.75	5.25	V
V _{cc3} ²	3.3V Supply Voltage		n/a	n/a	V
V _{cc12} ²	12V Supply Voltage		n/a	n/a	V
V _{cc-12} ²	-12V Supply Voltage		n/a	n/a	V
T _a	Operating Temperature		-40	+85	C
T _s	Storage Temperature		-55	+125	C
RH	Relative Humidity	Non-Condensing	0	90%	%

2.2 Electrical Characteristics

Table 3: Electrical Characteristics

Symbol	Parameter	Test Condition	Max	Unit
P ¹	Power Consumption	V _{cc5} = 5.0V	1.0	mW
Current Between Buses (ADP086-2 only)				
I _{BUS3.3} ²	3.3V Current between buses		0.0	A
I _{BUS5}	5V Current between buses		0.0	A
I _{BUS5-STBY} ³	5V Standby Current between buses		0.0	A
I _{BOCUS12} ²	12V Current between buses		0.0	A
USB Ports				
I _{oc}	Overcurrent Limit	Both ports (combined)	0.8	A

NOTE: On the ADP086-2, +5V Standby (V_{cc5-STBY}) is connected to the PCIe/104 Type 2 bus but not the PCI bus connector. This is by design, as usage of the ADP086-2 requires a PCIe/104 Type 2 bus connector.



The PCI bus connector on the ADP086-2 exists to pass through the host's PCI bus to PCI peripheral devices above or below the ADP086-2.

¹ Power consumption does not include current drawn from connected USB devices.

² The 3.3V, 12V, and -12V rails are not used by the ADP086. Any requirements on these signals are driven by other components in the system.

³ If supported by the host, 5V Standby may be used to power the board when the main power supply is turned off, permitting a means for USB to wake the system in low power modes. It is not required for board operation.

3 Board Connection

3.1 Board Handling Precautions

To prevent damage due to Electrostatic Discharge (ESD), keep your board in its antistatic bag until you are ready to install it into your system. When removing it from the bag, hold the board at the edges, and do not touch the components or connectors. Handle the board in an antistatic environment, and use a grounded workbench for testing and handling of your hardware.

3.2 Physical Characteristics

STEP model is available upon request; contact RTD Tech Support for more information.

- Weight: Approximately 0.05 Kg (0.11 lbs.)
- Dimensions: 90.17 mm L x 95.89 mm W (3.550 in L x 3.775 in W)

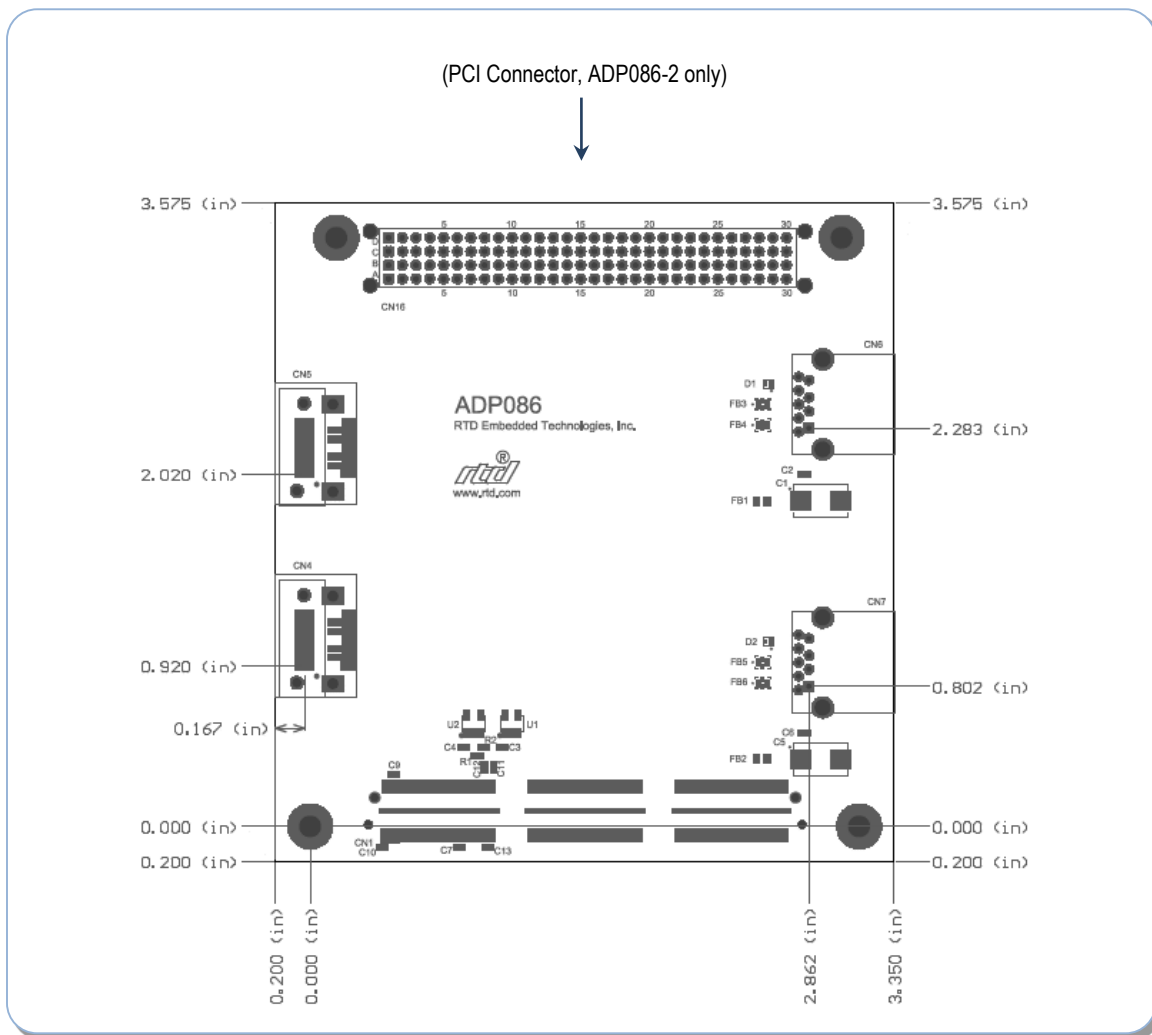

Figure 3: Board Dimensions (inches)

3.3 Connectors and Jumpers

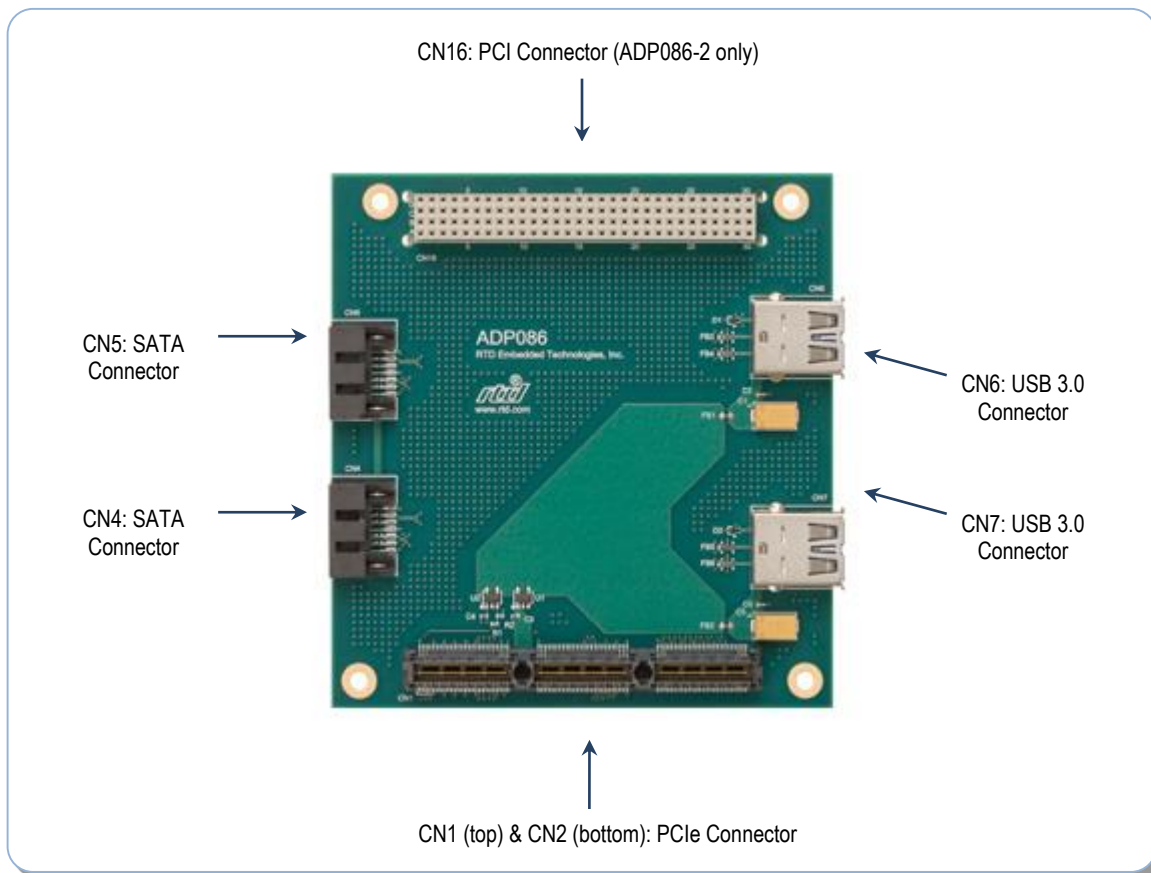

Figure 4: Board Connections

3.3.1 EXTERNAL I/O CONNECTORS

CN6 & CN7: USB 3.0 Connectors

Two USB 3.0 compliant connectors are available on the ADP086. With the ADP086 stacked below the CPU, CN6 breaks out the higher order port, and connector CN7 breaks out the lower order port.

Table 4: USB Port Connections

ADP086 Stack Location	CN7	CN6
Stacked Below the CPU	CPU bottom-side port 0	CPU bottom-side port 1



NOTE: For proper operation at USB 3.0 (or USB 2.0) speeds, be sure to use a cable that is rated for USB 3.0 (or USB 2.0)

CN4 & CN5: SATA Connectors

Two right angle SATA connectors are available on the ADP086. With the ADP086 stacked below the CPU, CN4 breaks out the higher order port, and connector CN5 breaks out the lower order port. Both connectors permit connectivity with latching or non-latching SATA cables.

Table 5: SATA Port Connections

ADP086 Stack Location	CN5	CN4
Stacked Below the CPU	CPU bottom-side port 0	CPU bottom-side port 1

3.3.2 BUS CONNECTORS

CN1 (Top) & CN2 (Bottom): PCIe Connector

The PCIe connector is the connection to the system CPU. The position and pin assignments are compliant with the *PCI/104-Express Specification*. (See PC/104 Specifications on page 15)

The ADP086 is a Type 2 board, and must connect to a Type 2 PCIe/104 connector.

CN3: PCI Connector (ADP086-2 only)

The PCI connector provides a pass-through connection for the host and PCI peripheral modules. The position and pin assignments are compliant with the *PCI/104-Express Specification*. (See PC/104 Specifications on page 15)

3.4 Selecting the Stack Order for the ADP086

The following is a list of rules to determine where the ADP086 falls within the stacking order of the system. These rules may be overridden by the devices hosting the USB 3.0 and SATA connections.

1. If a SATA link is used (with no USB 3.0 link), the ADP086 must be placed within six boards of the CPU.
2. If a USB 3.0 link is used, the ADP086 must be within four boards of the CPU.
3. If a USB 3.0 link is used, the ADP086 must be closer to the CPU than any board that uses a USB 2.0 link.

For systems with PCI devices, the ADP086-2 (PCI/104-Express) may be required to meet these stacking requirements while allowing the PCI bus to pass through to other boards within the system.

3.5 Steps for Installing

1. Always work at an ESD protected workstation, and wear a grounded wrist-strap.
2. Turn off power to the PC/104 system or stack.
3. Select and install stand-offs to properly position the module on the stack.
4. Remove the module from its anti-static bag.
5. Check that pins of the bus connector are properly positioned.
6. Check the stacking order; make sure all of the busses used by the peripheral cards are connected to the cpuModule.
7. Hold the module by its edges and orient it so the bus connector pins line up with the matching connector on the stack.
8. Gently and evenly press the module onto the PC/104 stack.
9. If any boards are to be stacked above this module, install them.
10. Attach any necessary cables to the PC/104 stack.
11. Re-connect the power cord and apply power to the stack.
12. Boot the system and verify that all of the hardware is working properly.

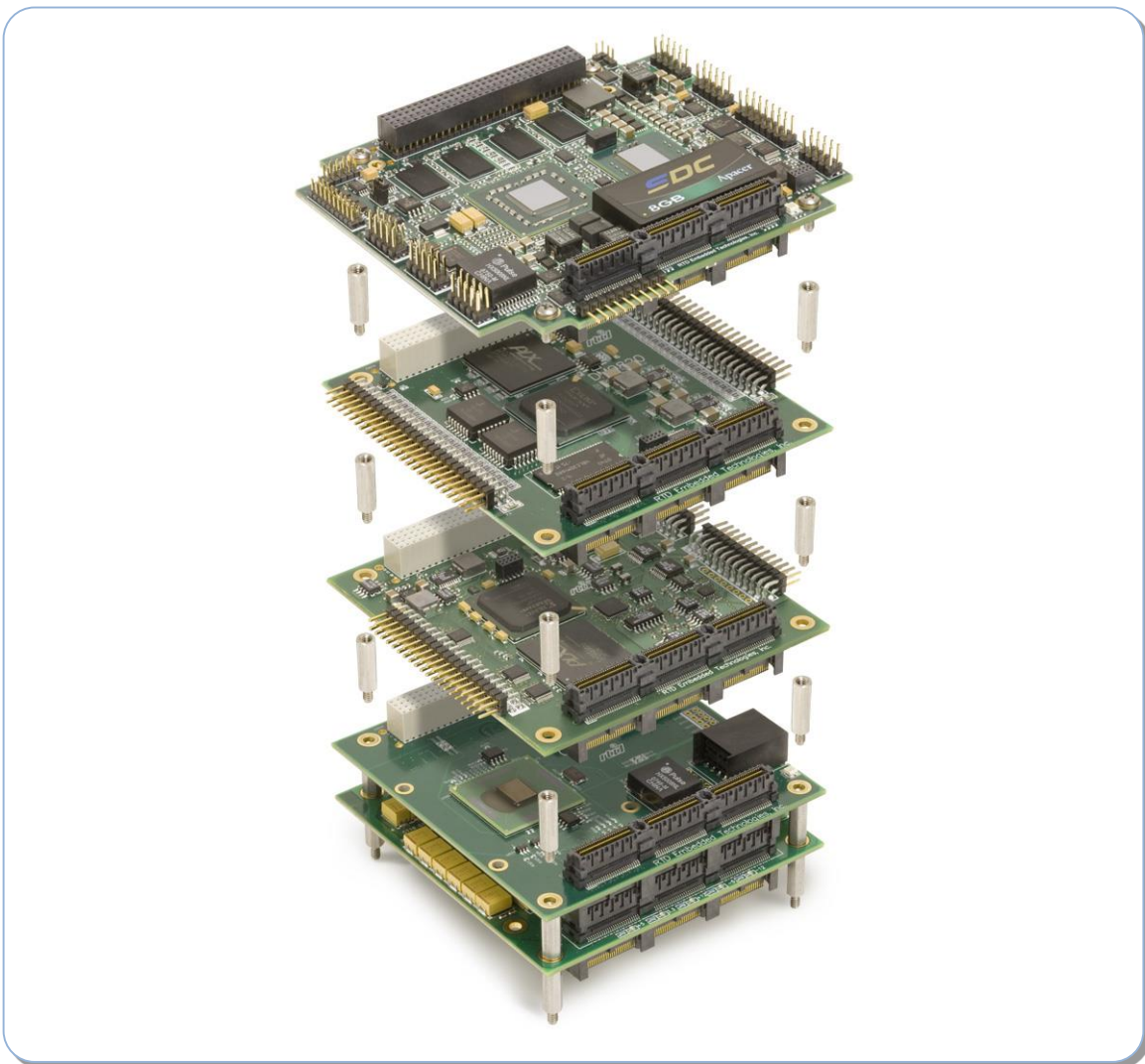

Figure 5: Example 104™ Stack

4 Functional Description

4.1 Functional Diagram

The Figure below shows the functional diagram of the ADP086. The various parts of the block diagram are discussed in the following sections.

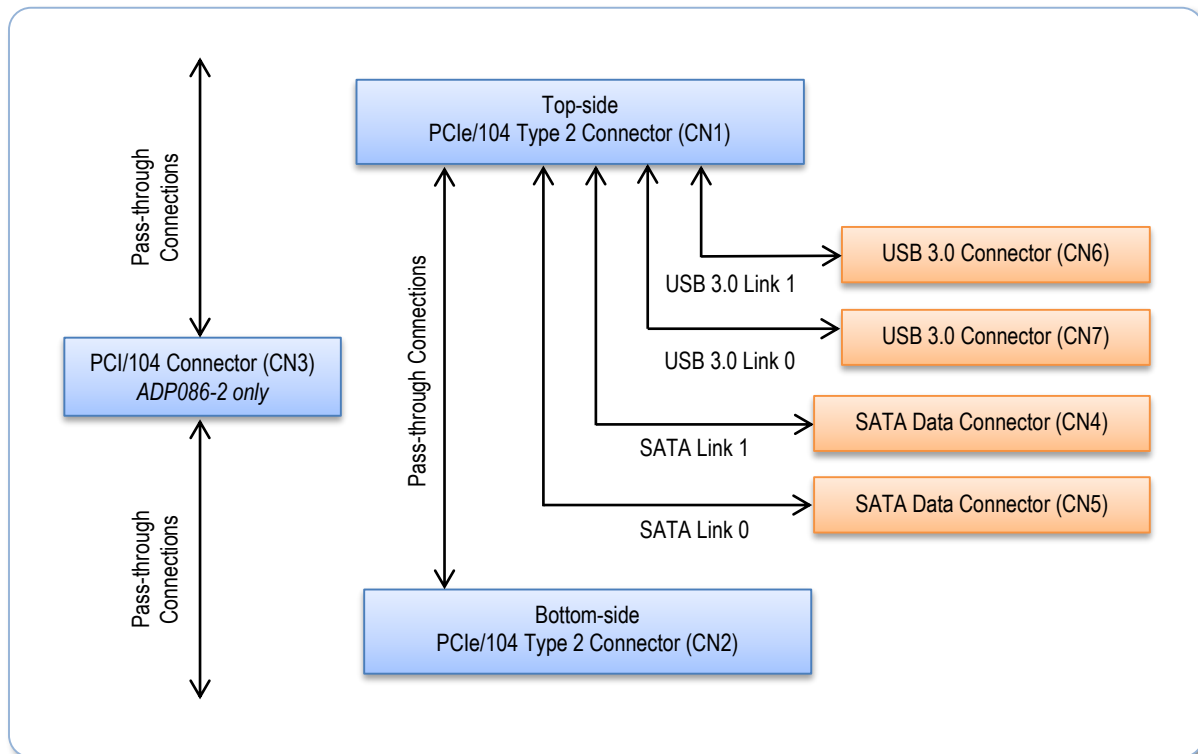

Figure 6: ADP086 Functional Diagram

4.2 Backwards Compatibility with USB 2.0

A USB 3.0 connection requires three differential pairs on the PCIe bus connector. These are the TX and RX differential pairs for SuperSpeed, and a bi-directional differential pair for high-speed, full-speed, and low-speed signaling rates. Typically, a USB 3.0 hub will use both sets of signals, and USB devices will use one set or the other. If the CPU only provides USB 2.0 links (no TX and RX differential pairs for SuperSpeed), the bi-directional differential pairs on the ADP086's USB ports (CN6 and CN7) may be utilized to connect USB devices at high-speed, full-speed, and low-speed signaling rates.

4.3 Power

The ADP086 only requires +5V (V_{CC5}) to operate and may be supplied on either the PCIe or PCI side of the ADP086. Although not required, +5V Standby ($V_{CC5-STBY}$) may be provided on the PCIe connector to permit waking the system if supported by the host.



NOTE: On the ADP086-2, +5V Standby ($V_{CC5-STBY}$) is connected to the PCIe/104 Type 2 bus but not the PCI bus connector. This is by design, as usage of the ADP086-2 requires a PCIe/104 Type 2 bus connector. The PCI bus connector on the ADP086-2 exists to pass through the host's PCI bus to PCI peripheral devices above or below the ADP086-2.

Acceptable voltage ranges for +5V (V_{CC5}) and +5V Standby ($V_{CC5-STBY}$) are listed in Table 2: Operating Conditions.

5 Troubleshooting

If you are having problems with your system, please try the following initial steps:

- **Simplify the System** – Remove modules one at a time from your system to see if there is a specific module that is causing a problem. Perform your troubleshooting with the least number of modules in the system possible.
- **Swap Components** – Try replacing parts in the system one at a time with similar parts to determine if a part is faulty or if a type of part is configured incorrectly.

If problems persist, or you have questions about configuring this product, contact RTD Embedded Technologies via the following methods:

Phone: +1-814-234-8087
E-Mail: techsupport@rtd.com

Be sure to check the RTD web site (<http://www.rtd.com>) frequently for product updates, including newer versions of the board manual and application software.

6 Additional Information

6.1 PC/104 Specifications

A copy of the latest PC/104 specifications can be found on the webpage for the PC/104 Embedded Consortium:

www.pc104.org

6.2 PCI and PCI Express Specification

A copy of the latest PCI and PCI Express specifications can be found on the webpage for the PCI Special Interest Group:

www.pcisig.com

7 Limited Warranty

RTD Embedded Technologies, Inc. warrants the hardware and software products it manufactures and produces to be free from defects in materials and workmanship for one year following the date of shipment from RTD Embedded Technologies, Inc. This warranty is limited to the original purchaser of product and is not transferable.

During the one year warranty period, RTD Embedded Technologies will repair or replace, at its option, any defective products or parts at no additional charge, provided that the product is returned, shipping prepaid, to RTD Embedded Technologies. All replaced parts and products become the property of RTD Embedded Technologies. Before returning any product for repair, customers are required to contact the factory for a Return Material Authorization (RMA) number.

This limited warranty does not extend to any products which have been damaged as a result of accident, misuse, abuse (such as: use of incorrect input voltages, improper or insufficient ventilation, failure to follow the operating instructions that are provided by RTD Embedded Technologies, "acts of God" or other contingencies beyond the control of RTD Embedded Technologies), or as a result of service or modification by anyone other than RTD Embedded Technologies. Except as expressly set forth above, no other warranties are expressed or implied, including, but not limited to, any implied warranties of merchantability and fitness for a particular purpose, and RTD Embedded Technologies expressly disclaims all warranties not stated herein. All implied warranties, including implied warranties for merchantability and fitness for a particular purpose, are limited to the duration of this warranty. In the event the product is not free from defects as warranted above, the purchaser's sole remedy shall be repair or replacement as provided above. Under no circumstances will RTD Embedded Technologies be liable to the purchaser or any user for any damages, including any incidental or consequential damages, expenses, lost profits, lost savings, or other damages arising out of the use or inability to use the product.

Some states do not allow the exclusion or limitation of incidental or consequential damages for consumer products, and some states do not allow limitations on how long an implied warranty lasts, so the above limitations or exclusions may not apply to you.

This warranty gives you specific legal rights, and you may also have other rights which vary from state to state.

RTD Embedded Technologies, Inc.

103 Innovation Boulevard
State College, PA 16803 USA
Telephone: 814-234-8087
Fax: 814-234-5218

www.rtd.com

sales@rtd.com
techsupport@rtd.com

